



**BUREAU
VERITAS**

TEST REPORT EN 50438

**Requirements for the connection of micro-generators
in parallel with public low-voltage distribution networks**

| | |
|--------------------------------------|---|
| Report reference number | PV140508N005-2 |
| Date of issue | 2014-07-22 |
| Total number of pages | 127 |
| Testing laboratory name | Bureau Veritas Shenzhen Co., Ltd. Dongguan Branch |
| Address | No. 34, Chenwulu Section, Guantai Rd., Houjie Town, Dongguan City, Guangdong 523942, China |
| |  |
| Applicant's name | Shenzhen SOFARSOLAR Co., Ltd. |
| Address | 3A-1, Huake Building, East Technology Park, Qiaoxiang Road, Nanshan District, Shenzhen, China. |
| Test specification | |
| Standard | EN 50438:2007 DIN EN 50438:2008 with deviations according the national network and system protection for Poland DIN V VDE V 0126-1-1:2006-02 |
| Certificate | Certificate of compliance |
| Test report form number | EN50438 |
| Master TRF | Bureau Veritas Consumer Products Services Germany GmbH |
| Test item description | Grid connected photovoltaic inverter |
| Trademark |  |
| Model / Type | SOFAR 1100TL, SOFAR 1600TL, SOFAR 2200TL, SOFAR 2700TL, SOFAR 3000TL |

| | | | | | |
|-----------------------------------|------------------|-----------------|-------------------|-----------------|-----------------|
| Ratings | SOFAR 1100TL | SOFAR 1600TL | SOFAR 2200TL | SOFAR 2700TL | SOFAR 3000TL |
| MPP DC voltage range [V]..... : | 110-380 | 165-380 | 170-450 | 210-450 | 230-450 |
| Input DC voltage range [V]..... : | 90-400, max. 450 | | 100-480, max. 500 | | |
| Input DC current [A] | Max.10 | | Max.13 | | |
| Output AC voltage [V] | 230V, 50Hz | | | | |
| Output AC current [A]..... : | Max.4,5 | Max.7,0 | Max.9,5 | Max.11,5 | Max.13,0 |
| Output power [W] | 1000 | 1500 | 2000 | 2500 | 2800 |

| | |
|--|--|
| Testing Location | Bureau Veritas Shenzhen Co., Ltd. Dongguan Branch |
| Address | No. 34, Chenwulu Section, Guantai Rd., Houjie Town, Dongguan City, Guangdong 523942, China |
| Tested by (name and signature)..... | James Huang  |
| Approved by (name and signature)..... | Corney Zhang  |
| Manufacturer's name | Shenzhen SOFARSOLAR Co., Ltd. |
| Factory address | No. 8, Fulong road, Qingxi town, Dongguan city, Guangdong, China. |

| Document History | | | |
|----------------------------|---------------------------|---------------------------------------|-----------------|
| Date | Internal reference | Modification / Change / Status | Revision |
| 2014-07-22 | James Huang | Initial report was written | 0 |
| Supplementary information: | | | |

| | |
|---|--|
| Test items particulars | |
| Equipment mobility..... | Permanent connection |
| Operating condition..... | Continuous |
| Class of equipment | Class I |
| Protection against ingress of water.. | IP65 according to EN 60529 |
| Mass of equipment [kg]..... | SOFAR 1100TL, SOFAR 1600TL, SOFAR 2200TL: 11kg SOFAR 2700TL, SOFAR 3000TL: 12kg |
| Test case verdicts | |
| Test case does not apply to the test object..... | N/A |
| Test item does meet the requirement..... | P(ass) |
| Test item does not meet the requirement..... | F(ail) |
| Testing | |
| Date of receipt of test item | 2014-05-08 |
| Date(s) of performance test | 2014-05-08 to 2014-07-01 |
| General remarks: | |
| <p>The test result presented in this report relate only to the object(s) tested. This report must not be reproduced in part or in full without the written approval of the issuing testing laboratory. "(see Annex #)" refers to additional information appended to the report. "(see appended table)" refers to a table appended to the report. Throughout this report a comma is used as the decimal separator.</p> | |
| This Test Report consists of the following documents: | |
| <ol style="list-style-type: none"> 1. Test Results 2. Annex No. 1 – EMC Test Report 3. Annex No. 2 – Pictures of the units 4. Annex No. 3 – Test equipment list | |

Copy of marking plate:

| SOFAR SOLAR | |
|---|--------------|
| PV Grid Inverter | SOFAR 1100TL |
| Maximum DC input voltage | 450V |
| DC voltage range | 90-400V |
| Maximum DC input current | 10A |
| Maximum PV Isc | 12A |
| Nominal Grid voltage | L/N/PE 230V~ |
| Maximum AC output current | 4.5A |
| Nominal Grid frequency | 50Hz |
| Maximum AC output power | 1000W |
| Power factor | 1 |
| Ingress protection | IP65 |
| Operating temperature range | -25-+60°C |
| Protective class | Class I |
| Manufacturer: Shenzhen SOFARSOLAR Co., Ltd. Made in China | |
| VDE0126-1-1, VDE-AR-N 4105, G83/2, EN50438, C10/11, AS4777, RD1699, UTE C15-712-1 | |
|  | |

| SOFAR SOLAR | |
|---|--------------|
| PV Grid Inverter | SOFAR 1600TL |
| Maximum DC input voltage | 450V |
| DC voltage range | 90-400V |
| Maximum DC input current | 10A |
| Maximum PV Isc | 12A |
| Nominal Grid voltage | L/N/PE 230V~ |
| Maximum AC output current | 7A |
| Nominal Grid frequency | 50Hz |
| Maximum AC output power | 1500W |
| Power factor | 1 |
| Ingress protection | IP65 |
| Operating temperature range | -25-+60°C |
| Protective class | Class I |
| Manufacturer: Shenzhen SOFARSOLAR Co., Ltd. Made in China | |
| VDE0126-1-1, VDE-AR-N 4105, G83/2, EN50438, C10/11, AS4777, RD1699, UTE C15-712-1 | |
|  | |

| SOFAR SOLAR | |
|---|--------------|
| PV Grid Inverter | SOFAR 2200TL |
| Maximum DC input voltage | 500V |
| DC voltage range | 100-480V |
| Maximum DC input current | 13A |
| Maximum PV Isc | 15A |
| Nominal Grid voltage | L/N/PE 230V~ |
| Maximum AC output current | 9.5A |
| Nominal Grid frequency | 50Hz |
| Maximum AC output power | 2000W |
| Power factor | 1 |
| Ingress protection | IP65 |
| Operating temperature range | -25-+60°C |
| Protective class | Class I |
| Manufacturer: Shenzhen SOFARSOLAR Co., Ltd. Made in China | |
| VDE0126-1-1, VDE-AR-N 4105, G83/2, EN50438, C10/11, AS4777, RD1699, UTE C15-712-1 | |
|  | |

| SOFAR SOLAR | |
|---|--------------|
| PV Grid Inverter | SOFAR 2700TL |
| Maximum DC input voltage | 500V |
| DC voltage range | 100-480V |
| Maximum DC input current | 13A |
| Maximum PV Isc | 15A |
| Nominal Grid voltage | L/N/PE 230V~ |
| Maximum AC output current | 11.5A |
| Nominal Grid frequency | 50Hz |
| Maximum AC output power | 2500W |
| Power factor | 1 |
| Ingress protection | IP65 |
| Operating temperature range | -25-+60°C |
| Protective class | Class I |
| Manufacturer: Shenzhen SOFARSOLAR Co., Ltd. Made in China | |
| VDE0126-1-1, VDE-AR-N 4105, G83/2, EN50438, C10/11, AS4777, RD1699, UTE C15-712-1 | |
|  | |

| SOFAR SOLAR | |
|--|--------------|
| PV Grid Inverter | SOFAR 3000TL |
| Maximum DC input voltage | 500V |
| DC voltage range | 100-480V |
| Maximum DC input current | 13A |
| Maximum PV Isc | 15A |
| Nominal Grid voltage | L/N/PE 230V~ |
| Maximum AC output current | 13A |
| Nominal Grid frequency | 50Hz |
| Maximum AC output power | 2800W |
| Power factor | 1 |
| Ingress protection | IP65 |
| Operating temperature range | -25-+60°C |
| Protective class | Class I |
| Manufacturer: Shenzhen SOFARSOLAR Co., Ltd. Made in China | |
| VDE0126-1-1, VDE-AR-N 4105, G83/2, EN50438, C10/11, AS4777, RD1699, UTE C15-712-1 | |
|  | |

General product information:

The Solar converter converts DC voltage into AC voltage.

The input and output are protected by varistors to Earth. The unit is providing EMC filtering at the PV input and output toward mains. The unit does not provide galvanic separation from input to output (transformerless). The output is switched off redundantly by the high power switching bridge and two relays. This assures that the opening of the output circuit will also operate in case of a single error.

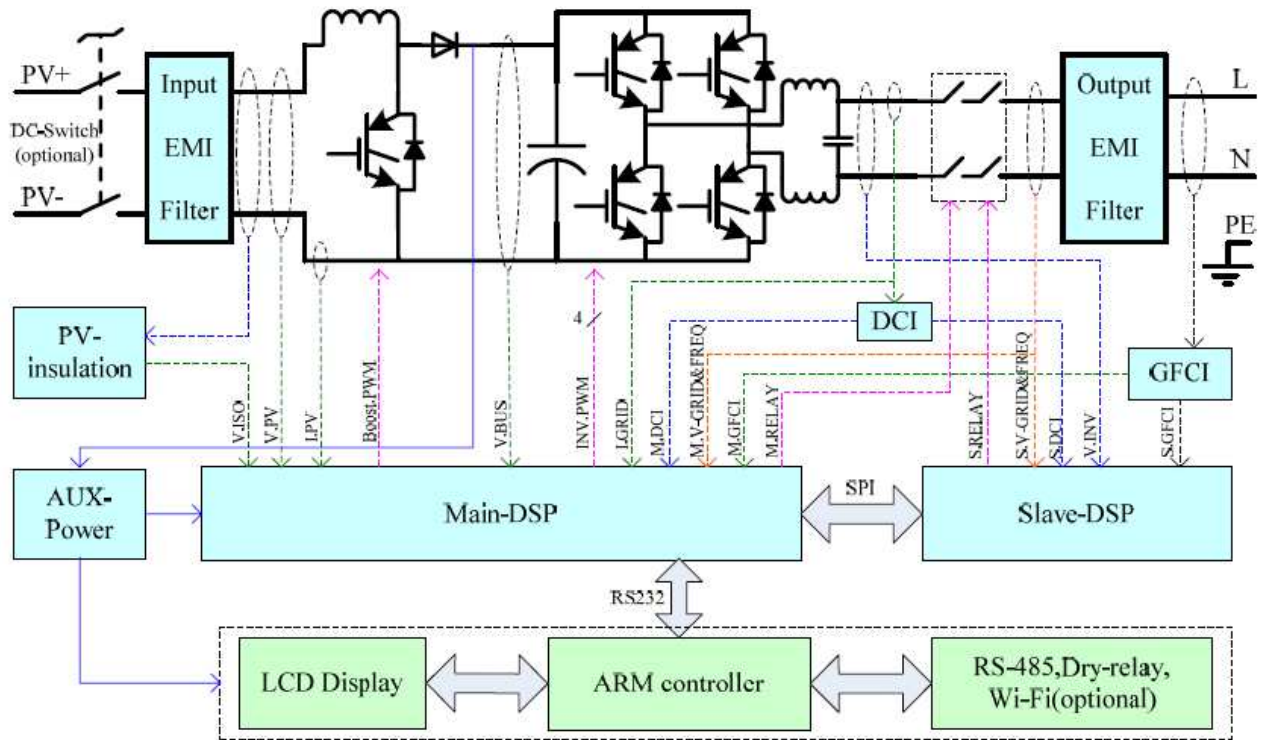

The internal control is redundant built. It consists of Microcontroller Master DSP (UC34) and Slave DSP (UC35).

The Master DSP control the relays (RYP2-RYP5) by switching signals; measures the PV voltage, PV current, Bus voltage, grid voltage and frequency, AC current with injected DC and the array insulation resistance to ground. In addition it tests the current sensors and the RCMU circuit before each start up.

The Slave DSP (UC35) is measures the grid voltage, AC current, grid frequency and residual current, also can switch off the relays (RYP2-RYP5) independently, and communicate with Master DSP (UC34) each other.

The current is measured by a current sensor. The AC current signal and the injected DC current signal are sent to the Master DSP (UC34). The Master DSP (UC34) tests and calibrates before each start up all current sensors.

The unit provides two relays in series in all output conductors. When single fault applied to one relay, alarm an error code in display panel, another redundant relay provides basic insulation maintained between the PV array and the mains. All the relays are tested before each start up.

Differences of the models

The models SOFAR 1100TL, SOFAR 1600TL, SOFAR 2200TL, SOFAR 2700TL and SOFAR 3000TL are same as in hardware except the components are in the difference table. Identical in software the output power just adjusted by software.

| Difference table | | | | | |
|--|---------------------------|--------------------------|--------------------------|--------------------------|--------------------------|
| | SOFAR 1100TL | SOFAR 1600TL | SOFAR 2500TL | SOFAR 2700TL | SOFAR 3000TL |
| Boost inductor | 2,6mH | 2,6mH | 1,9mH | 1,9mH | 1,9mH |
| Resistor (RP105, RP108 /RP189,RP109) | 220ohm / 10Kohm | 220ohm / 10Kohm | 200ohm / 7,5Kohm | 200ohm / 7,5Kohm | 200ohm / 7,5Kohm |
| BUS capacitor (ECP1, ECP2, ECP3, ECP4) | 2 pcs | 2 pcs | 3 pcs | 3 pcs | 3 or 4 pcs |
| Inverter inductor | 3,4mH | 2,3mH | 2,1mH | 1,5mH | 1,3mH |
| Resistor (RP118, RP119, RC18 /RP120, RP121,RC22) | 499 Ω, 200 Ω, 200 Ω | 1 KΩ, 200 Ω, 100 Ω | 1 KΩ, 330 Ω, 330 Ω | 2 KΩ, 100 Ω, 100 Ω | 2 KΩ, 100 Ω, 100 Ω |
| DC switch and Wi-Fi module are optional. | | | | | |

The product was tested on:
Hardware version: V1.00
Software version: V1.00

| Default interface protection settings according EN 50438:2007: (Poland) | | |
|---|--|---------------------|
| Parameter | Max. clearance time | Trip setting |
| Over voltage | 0,2s | 230V +15% (264,5V) |
| Under voltage | 1,5s | 230V -15% (195,5V) |
| Over frequency | 0,5s | 50Hz +2% (51,0Hz) |
| Under frequency | 0,5s | 50Hz -6% (47,0Hz) |
| Reconnection time | >=20s | |
| Permanent DC-injection | 0,5% of rated inverter output current | |
| Loss of main DIN V VDE V 0126-1-1:2006 | Inverter shall detect and disconnect within 5s | |
| <p>The stated currents and voltages are 'true r.m.s.'-values. The voltages in this table are - phase-to-neutral in 230 V single phase systems and 230/400 V systems, - phase-to-phase in a multiphase 230 V system.</p> | | |
| <p>*Over voltage – stage1: 10min mean value corresponding to EN 50160 Tolerances on trip values: - Voltage: +/- 1% of the nominal voltage; - Frequency: +/- 0,5% of the nominal frequency - Clearance time: +/- 10%</p> | | |

| EN 50438:2007 | | | |
|---------------|--------------|---------|---------|
| Clause/§ | Requirement: | Remark: | Verdict |

| | | | |
|----------|--|--|--|
| 1 | Scope (Micro-generators up to 16A on the public low-voltage grid) | | |
|----------|--|--|--|

| | | | |
|----------|-----------------------------|------------------------------|--|
| 2 | Normative references | | |
| | | EN 50110 series | |
| | | EN 50160 | |
| | | EN 60255-6 | |
| | | EN 60664-1 | |
| | | EN 61000-3-2 | |
| | | EN 61000-3-3 | |
| | | EN 61000-6-1 | |
| | | EN 61000-6-3:2001 + A11:2004 | |
| | | HD 384 / HD 60364 series | |
| | | IEC 60364-5-55 | |

| | | | |
|----------|------------------------------|--|--|
| 3 | Terms and definitions | | |
|----------|------------------------------|--|--|

| | | | |
|----------|--|--|----------|
| 4 | Connection requirements: | | |
| 4.1 | The electrical installation.....: | The installation shall be in compliance with HD 384 series and national and local regulation. | P |
| 4.1.1 | Installation instructions.....: | Maintenance in accordance with the instructions issued by the manufacturer | P |
| 4.1.2 | Over-current protection.....: | The manufacturer recommends an over-current protection device in the manual | P |
| 4.1.3 | Earthing.....: | Earthing shall be according to HD 384.5.54 / IEC 60364-5-55 and the relevant national standards. | P |
| 4.2 | Interface protection | | P |
| 4.2.1 | General.....: | The interface protection, monitoring and control functions are integral part of the inverter. | P |
| 4.2.1.1 | Default settings versus national settings.....: | Default settings of table 2 are applied | P |
| 4.2.1.2 | Response to protection operation.....: | See table 4.2.1.2 below | P |
| 4.2.1.3 | Accessibility of isolation switching devices.....: | The transformerless unit provides two disconnection devices in series. | P |

| EN 50438:2007 | | | |
|--|---|--|----------------|
| Clause/§ | Requirement: | Remark: | Verdict |
| 4.2.1.4 | Place of the interface protection.....: | The interface protection is integral part of the inverter and conform to EN 60255-6 or equivalent. The manufacturer declares conformity of his product to this standard within the CE declaration of conformity. | P |
| 4.2.1.5 | Changing settings of the interface protection.....: | It is not possible for the user to alter the interface protection settings | P |
| 4.2.1.6 | Combined protection devices for multiple generators.....: | The proper combined working of the protection is ensured | P |
| 4.2.2 | Interface protection settings.....: | Default interface protection settings are applied, see table 4.2.2 below | P |
| 4.2.3 | Loss of Mains protection.....: | Loss of mains protection is required (see Annex A) | P |
| 4.2.4 | Automatic reconnection after a network outage....: | >20s, see table 4.2.2 below | P |
| 4.2.5 | Synchronisation.....: | Automatic synchronisation of the inverter | P |
| 5 | | | |
| Power quality: | | | |
| 5.1 | Electromagnetic emission / immunity.....: | The inverter complies with the requirements of the EMC directive, see attached EMC report in Annex 1 | P |
| | EN 61000-6-1 (immunity) | | P |
| | EN 61000-6-3 + A11 (emission) | | P |
| | EN 61000-3-2 (harmonics) | | P |
| | EN 61000-3-3 (voltage fluctuations and flicker) | | P |
| 5.2 | DC injection.....: | Nearly no DC injection, see table 5.2 below | P |
| 5.3 | Power factor.....: | See table 5.3 below | P |
| 6 | | | |
| Operation and safety of the micro-generator | | | |
| 6.1 | General.....: | The unit operates safely over the declared operating range | P |
| 6.2 | Safety.....: | This standard does not cover safety of DNO personnel. | P |

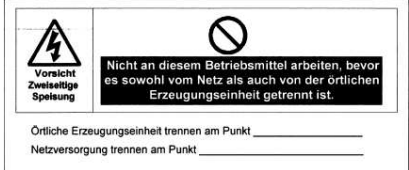
| EN 50438:2007 | | | |
|---------------------------|--|--|----------------|
| Clause/§ | Requirement: | Remark: | Verdict |
| 6.3 | Information plate.....: | At least information of manufacturers name, identification, rated power, nom. voltage, nom. frequency, phases and power factor, see above marking plate. | P |
| 6.4 | Labelling.....: | The unit provides the following warning label:  | P |
| 6.5 | Maintainance and routine testing.....: | The manufacturer provides information for maintainance in the manual. The units are routine tested in the factory. | P |
| 7 | | | |
| Commissioning | | | |
| 7.1 | General | | P |
| | The micro-generator (including the interface protection) shall fulfil the requirements of this standard and the other applicable standards.....: | Noticed | - |
| | The manufacturer shall provide an installation instruction in accordance with this standard and national or regional requirements.....: | Verified, see manual. | - |
| | Access to the interface protection shall be tamper-proof.....: | Access just via password, provided by the manufacturer | - |
| | The micro-generator shall be type tested against the interface requirements of this standard.....: | Noticed, see test tables below | - |
| | The installation shall be carried out by installer with recognised and approved qualification | Not scope of investigation | - |
| 7.2 | Installation | Not scope of investigation | N/A |
| 7.3 | Notification | | N/A |
| 7.4 | Decommissioning arrangements | | N/A |
| 7.5 | Replacement arrangements | | N/A |
| Annex | | | |
| A (normative) | Interface protection settings, national deviations | No specific national settings are supplied, the default settings in 4.2.2, table 2 are applicable | N/A |
| B (informative) | Notification sheets | | N/A |
| C (informative) | Interface protection | Noticed | P |

| EN 50438:2007 | | | |
|---------------------------|---|----------------|----------------|
| Clause/§ | Requirement: | Remark: | Verdict |
| D (informative) | Type certification test results sheet | Noticed | P |
| E (informative) | Countries allowing extensions of the scope >16A | | N/A |
| F (informative) | Abbreviations | Noticed | P |
| G (informative) | A-deviations | | N/A |

| EN 50438:2007 | | |
|---------------|---|--------|
| Clause | Test | Result |
| 4.2.1.2 | Response to protection operation | P |
| 4.2.2 | Interface protection settings | P |
| 4.2.3 | Loss of Mains protection | P |
| 4.2.4 | Automatic reconnection after a network outage | P |
| 5.1 | Harmonic current emission | P |
| 5.1 | Voltage fluctuation and flicker | P |
| 5.2 | DC injection | P |
| 5.3 | Power factor | P |

Test Results

| 4.2.1.2 Response to protection operation - fault condition tests according DIN V VDE V 0126-1-1:2006-02 | | | | | | | | P |
|---|----------------------------------|---------------------------------------|-------------------|-----------|----------|-----------------|---------------|--|
| | ambient temperature [°C] : | 23,8 | | | | | | — |
| | model/type of power supply : | DC : 62150H-1000S AC : 61512 | | | | | | — |
| | manufacturer of power supply : | Chroma | | | | | | — |
| | rated markings of power supply : | DC: 0-1000V, 15kW AC: 0-300V, 18kW | | | | | | — |
| component No. | fault | test condition | | test time | fuse No. | fault condition | | result |
| | | AC | DC | | | AC | DC | |
| PV voltage detect UC1C Pin 9 | Open | 230V 12,63 A | 450V 6,62 A | 2 Min. | -- | 230V 0,17A | 450V 0,02A | PV inverter disconnected from grid immediately, error message: ID09. (PV voltage over range) |
| PV current detect UC1B Pin 5 | Open | 230V 12,63 A | 450V 6,6A | 2 Min. | -- | 230V 0,16A | 450V 0,02A | PV inverter disconnected from grid immediately, error message: ID14. (PV current over range) |
| GFCI detect UC2D Pin 12-13 | Short | 230V 12,63 A | 450V 6,62 A | 2 Min. | -- | 230V 0,16A | 450V 0,02A | PV inverter disconnected from grid immediately, error message: ID12. (GFCI fault) |
| GFCI detect UC2C Pin 10 | Short | 230V 12,63 A | 450V 6,62 A | 2 Min. | -- | 230V 0,16A | 450V 0,02A | PV inverter disconnected from grid immediately, error message: ID52. (GFCI fault) |
| Grid voltage detect UC2A Pin 3 | Open | 230V 12,64 A | 450V 6,67 A | 2 Min. | -- | 230V 0,17A | 450V 0,02A | PV inverter disconnected from grid immediately, error message: ID15. (Grid current or voltage over range) |
| Grid voltage detect RC17 | Open | 230V 12,63 A | 450V 6,62 A | 2 Min. | -- | 230V 0,17A | 450V 0,01A | PV inverter disconnected from grid immediately, error message: ID02, ID49, ID70. (Grid current or voltage under range) |
| Grid voltage detect RC25 | Open | 230V 12,64 A | 450V 6,62 A | 2 Min. | -- | 230V 0,18A | 450V 0,01A | PV inverter disconnected from grid immediately, error message: ID55. (Relay fault) |
| Bus voltage detect RP3 | Open | 230V 12,61 A | 450V 6,63 A | 2 Min. | -- | 230V 0,6A | 450V 0,02A | PV inverter disconnected from grid immediately, error message: ID23. (Bus voltage zero fault) |
| Bus voltage detect UC1A Pin2-3 | Short | 230V 12,56 A | 450V 6,65 A | 2 Min. | -- | 230V 0,17A | 450V 0,02A | PV inverter disconnected from grid immediately, error message: ID66. (Bus voltage over range) |

| component No. | fault | test condition | | test time | fuse No. | fault condition | | result |
|-------------------------|-------------------|--------------------|-------------------|-----------|----------|-----------------|---------------|--|
| | | AC | DC | | | AC | DC | |
| Bus voltage detect RC82 | Short | 230V 12,56 A | 450V 6,69 A | 2 Min. | -- | 230V 0,16A | 450V 0,02A | PV inverter disconnected from grid immediately, error message: ID25. (Bus voltage under range) |
| ISO detect RC105 | Open before start | 230V 0,17 A | 450V 0,18 A | 2 Min. | -- | 230V 0,17A | 450V 0,02A | PV inverter can not start up, error message: ID56. (ISO fault) |
| AC current detect RC22 | Open | 230V 12,56 | 450V 6,68 | 2 Min. | -- | 230V 0,17A | 450V 0,02A | PV inverter disconnected from grid immediately, error message: ID15. (AC current over range), QP2, QP6, QP9, RP26, RP28, RP11 damaged. |
| AC current detect RC21 | Open | 230V 12,62 A | 450V 6,63 A | 2 Min. | -- | 230V 0,16A | 450V 0,02A | PV inverter disconnected from grid immediately, error message: ID15. (AC current over range). |
| DC current detect RC33 | Open | 230V 12,67 A | 450V 6,69 A | 2 Min. | -- | 230V 0,17A | 450V 0,02A | PV inverter disconnected from grid immediately, error message: ID28. (DC current over range). |
| DC current detect RC37 | Open | 230V 12,54 A | 450V 6,67 A | 2 Min. | -- | 230V 0,17A | 450V 0,02A | PV inverter disconnected from grid immediately, error message: ID28. (DC current over range). |
| DC current detect RC42 | Open | 230V 12,62 A | 450V 6,66 A | 2 Min. | -- | 230V 0,16A | 450V 0,02A | PV inverter disconnected from grid immediately, error message: ID51. (DC current fault). |
| AC current detect RC61 | Open | 230V 12,66 A | 450V 6,7A | 2 Min. | -- | 230V 0,16A | 450V 0,02A | PV inverter disconnected from grid immediately, error message: ID15, ID65. (AC voltage or current over range). |
| AC current detect RC80 | Open | 230V 12,67 A | 450V 6,8A | 2 Min. | -- | 230V 0,16A | 450V 0,02A | PV inverter disconnected from grid immediately, error message: ID15, ID65. (AC voltage or current over range). |
| GFCI detect RP70 | Open | 230V 12,63 A | 450V 6,66 A | 2 Min. | -- | 230V 0,16A | 450V 0,02A | PV inverter disconnected from grid immediately, error message: ID12. (GFCI fault). |
| GFCI detect RP80 | Open | 230V 12,63 A | 450V 6,66 | 2 Min. | -- | 230V 0,16A | 450V 0,02A | PV inverter disconnected from grid immediately, error message: ID12. (GFCI fault). |
| GFCI detect UP7A Pin2-3 | Short | 230V 12,56 A | 450V 6,67 A | 2 Min. | -- | 230V 0,17A | 450V 0,02A | PV inverter disconnected from grid immediately, error message: ID12. (GFCI fault). |

| component No. | fault | test condition | | test time | fuse No. | fault condition | | result |
|---------------------------|--------------------|--------------------|-------------------|-----------|----------|-----------------|---------------|--|
| | | AC | DC | | | AC | DC | |
| PV voltage detect RP115 | Open | 230V 12,62 A | 450V 6,67 A | 2 Min. | -- | 230V 0,16A | 450V 0,02A | PV inverter disconnected from grid immediately, no display, and reconnect to grid, error message: ID56. (ISO fault). |
| PV voltage detect RP115 | Short | 230V 12,63 A | 450V 6,63 A | 2 Min. | -- | 230V 0,16A | 450V 0,02A | PV inverter disconnected from grid immediately, error message: ID09. (PV voltage over range) |
| ISO detect RP99 | Open before start | 230V 0,16 A | 450V 0,02 A | 2 Min. | -- | 230V 0,16A | 450V 0,02A | PV inverter can not start up, error message: ID56. (ISO fault). |
| Relay detect RYP2 Pin3-4 | Short before start | 230V 0,16 A | 450V 0,02 A | 2 Min. | -- | 230V 0,16A | 450V 0,02A | PV inverter can not start up, error message: ID55, ID77. (Relay fault). |
| Relay detect RYP3 Pin3-4 | Short before start | 230V 0,16 A | 450V 0,02 A | 2 Min. | -- | 230V 0,16A | 450V 0,02A | PV inverter can not start up, error message: ID55, ID77. (Relay fault). |
| Relay detect RYP4 Pin3-4 | Short before start | 230V 0,16 A | 450V 0,02 A | 2 Min. | -- | 230V 0,16A | 450V 0,02A | PV inverter can not start up, error message: ID55, ID77. (Relay fault). |
| Relay detect RYP5 Pin3-4 | Short before start | 230V 0,16 A | 450V 0,02 A | 2 Min. | -- | 230V 0,16A | 450V 0,02A | PV inverter can not start up, error message: ID55, ID77. (Relay fault). |
| Grid voltage detect RP150 | Open | 230V 0,62 A | 450V 6,67 A | 2 Min. | -- | 230V 0,16A | 450V 0,02A | PV inverter disconnected from grid immediately, error message: ID02. (Grid voltage under range) |
| Grid voltage detect RP150 | Short | 230V 12,64 A | 450V 6,66 A | 2 Min. | -- | 230V 0,16A | 450V 0,02A | PV inverter disconnected from grid immediately, error message: ID01. (Grid voltage over range) |
| Grid voltage detect RP135 | Short | 230V 12,64 A | 450V 6,67 A | 2 Min. | -- | 230V 0,16A | 450V 0,02A | PV inverter disconnected from grid immediately, error message: ID01. (Grid voltage over range) |
| Grid voltage detect RP135 | Open | 230V 12,61 A | 450V 6,66 A | 2 Min. | -- | 230V 0,16A | 450V 0,02A | PV inverter disconnected from grid immediately, error message: ID02. (Grid voltage under range) |
| Loss of control CC100 | Short | 230V 12,61 A | 450V 6,67 A | 2 Min. | -- | 230V 0,16A | 450V 0,02A | PV inverter disconnected from grid immediately, error message: DSP communicate fail |
| Loss of control XLC | Short | 230V 12,63 A | 450V 6,65 A | 2 Min. | -- | 230V 0,16A | 450V 0,02A | PV inverter disconnected from grid immediately, error message: DSP communicate fail |

| component No. | fault | test condition | | test time | fuse No. | fault condition | | result |
|--|-------|--------------------|-------------------|-----------|----------|-----------------|---------------|--|
| | | AC | DC | | | AC | DC | |
| Communication microcontroller defect UC34 Pin 31 | Open | 230V 12,64 A | 450V 6,66 A | 2 Min. | -- | 230V 0.16A | 450V 0.02A | PV inverter disconnected from grid immediately, error message: ID 53 (SPI Communication fault) |
| Communication microcontroller defect UC34 Pin 37 | Open | 230V 12,64 A | 450V 6,66 A | 2 Min. | -- | 230V 0.17A | 450V 0.02A | PV inverter disconnected from grid immediately, error message: ID 53 (SPI Communication fault) |
| Communication microcontroller defect UC34 Pin 44 | Open | 230V 12,63 A | 450V 6,66 A | 2 Min. | -- | 230V 0.17A | 450V 0.02A | PV inverter disconnected from grid immediately, error message: ID 53 (SPI Communication fault) |
| Communication microcontroller defect UC34 Pin 47 | Open | 230V 12,64 A | 450V 6,67 A | 2 Min. | -- | 230V 0.17A | 450V 0.02A | PV inverter disconnected from grid immediately, error message: ID 53 (SPI Communication fault) |
| <p>The errors in the control circuit simulate that the safety is even under one error ensured. The tests had been performed on the SOFAR 3000TL is valid for the SOFAR 1100TL, SOFAR 1600TL, SOFAR 2200TL and SOFAR 2700TL, since it is same as in hardware and just power derated by software.</p> | | | | | | | | |
| Addendum – Shutdown device | | | | | | | | |
| Each active phase can be switched. (L and N) | | | | | | | | P |
| If no galvanic separation between AC and DC (PV): Two relays in series on each active phase are necessary to fulfil the basic insulation or simple separation based on the PV working voltage. | | | | | | | | P |

| 4.2.2 Interface protection settings – Over / under voltage (4.2.3) Automatic reconnection after a network outage | | | | | | P |
|---|--------------------------|----------------|--|-----------------------|-------------------------|------------|
| Test Condition | | | Output power: 1632W Frequency: 50+/-0,2Hz | | | |
| Phase | Limit [V] | Trip value [V] | Voltage step [V] | Reconnection time [s] | Disconnection time [ms] | Limit [ms] |
| L1 | 85% of U_n = 195,5 | 195,3 | 200V to 190V | 74 | 1415 | 1500 |
| | | | 200V to 190V | | 1410 | |
| | | | 200V to 190V | | 1416 | |
| | | | 200V to 190V | | 1412 | |
| | | | 200V to 190V | | 1420 | |
| | 115% of U_n = 264,5 | 264,2 | 259V to 269V | 74 | 162 | 200 |
| | | | 259V to 269V | | 156 | |
| | | | 259V to 269V | | 156 | |
| | | | 259V to 269V | | 152 | |
| | | | 259V to 269V | | 168 | |

Note:
Lower and upper threshold voltage shall not fall or rise below or above 2,3V of the trip value itself. The measurement shall take place at nominal frequency and any power.

The oscilloscope pictures below show the measured worst case disconnection times.

The tests had been performed on the SOFAR 3000TL is valid for the SOFAR 1100TL, SOFAR 1600TL, SOFAR 2200TL and SOFAR 2700TL, since it is same as in hardware and just power derated by software.

Undervoltage

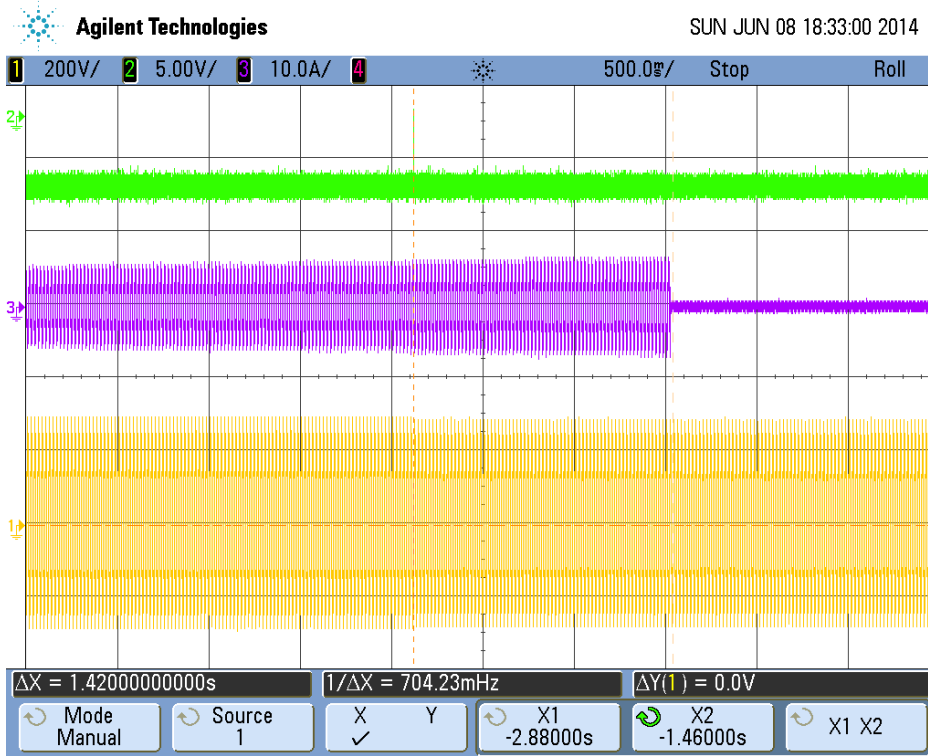

Overvoltage

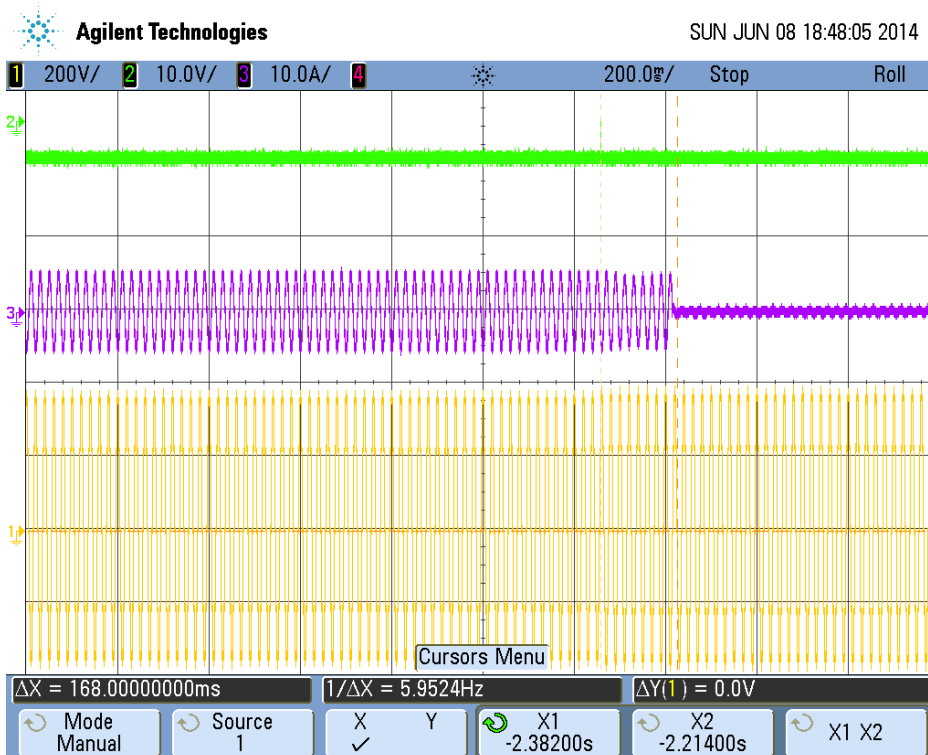

| 4.2.2 Measuring the rise-in voltage protection as a running 10-minute mean value Overvoltage protection according to DIN EN 50160:2000-03, 2.3 | | | P |
|--|--|------------------|--------------------------------------|
| Setting values of the protection: | Trip value Setting [V] | 264,5 | |
| | Setting $T_{\text{disconnection trip value}}$ [s] | 60 | |
| | Setting $T_{\text{disconnection}}$ [ms] | 140 | |
| Test: | | | |
| | Disconnection time [s] | Limit [s] | |
| a) | The voltage is set to 100% U_n and held for 600 s. Thereafter the voltage is set to 112% U_n . Disconnection must take place within 600 s. | | |
| | Phase 1: | 500 s | 600 s |
| | Phase 2: | N/A | |
| | Phase 3: | N/A | |
| b) | The voltage is set to U_n for 600 s and then to 108% U_n for 600 s. No disconnection should take place. | | |
| | Phase 1: | No disconnection | Disconnection should not take place. |
| | Phase 2: | N/A | |
| | Phase 3: | N/A | |
| c) | The voltage is set to 106 % U_n and held for 600 s. Thereafter the voltage is set to 114 % U_n . The disconnection should last for half the period as in Point a)* | | |
| | Phase 1: | 283 s | 300 s |
| | Phase 2: | N/A | |
| | Phase 3: | N/A | |
| Test: | | | |
| a) This test serves as proof of the measurement accuracy and the maximum set time. | | | |
| b) This test serves as proof of the measurement accuracy. | | | |
| c) This test serves as proof of the correct formation of the 10 minute running mean value. | | | |
| Assessment criterion: | | | |
| The permitted tolerance between setting value and trip value of the voltage may not exceed $\pm 1\%$ of U_N . | | | |
| <u>Limit values:</u> | | | |
| Rise-in voltage protection 1,1 U_N after a max. 600 s, the switch off after 200 ms. | | | |
| Note: | | | |
| If only one integrated protection is used for the power generation systems, the value of the rise-in voltage protection of 1,1 U_N may not be changed. | | | |
| The tests had been performed on the SOFAR 3000TL is valid for the SOFAR 1100TL, SOFAR 1600TL, SOFAR 2200TL and SOFAR 2700TL, since it is same as in hardware and just power derated by software. | | | |

| 4.2.2 Interface protection settings – Over / under frequency (4.2.4) Automatic reconnection after a network outage | | | | | | | | P |
|---|--|---------------|---------|----------------|------------------|---------------|---------|----------------|
| Test conditions | Output power: 1632W $U_N = 230V_{ac}$ | | | | | | | |
| | Under frequency | | | | Over frequency | | | |
| Parameter | Frequency | Time | | | Frequency | Time | | |
| Output Voltage | | ~85% of U_N | U_N | ~110% of U_N | | ~85% of U_N | U_N | ~110% of U_N |
| Limit | 47,00Hz | 500ms | 500ms | 500ms | 51,00Hz | 500ms | 500ms | 500ms |
| Trip value [Hz] | | 47,00Hz | 47,00Hz | 47,00Hz | | 51,02Hz | 51,02Hz | 51,02Hz |
| Disconnection time [ms] | 47,5Hz to 46,5Hz | 430 | 426 | 435 | 50,5Hz to 51,5Hz | 422 | 432 | 396 |
| | | 425 | 435 | 418 | | 424 | 434 | 414 |
| | | 430 | 420 | 432 | | 422 | 416 | 434 |
| | | 418 | 424 | 420 | | 420 | 432 | 420 |
| | | 424 | 436 | 422 | | 416 | 422 | 430 |
| Reconnection time [s]: | ≥ 20 | 74s | | | ≥ 20 | 74s | | |
| <p>Note: It was measured at a continuous change of frequency of 1Hz/s at lower, nominal and upper U_N and arbitrary output power. The trip value was determined manually by reducing the frequency in 10mHz steps. When the trip value is known (e.g. 48,02Hz), the ac-source is programmed to run from e.g. 48,50Hz to 47,50Hz with 1Hz/s. The disconnection time is calculated by the measured time minus the 480ms from 48,50Hz to 48,02Hz.</p> <p>The oscilloscope pictures below show the measured worst case disconnection times.</p> <p>The tests had been performed on the SOFAR 3000TL is valid for the SOFAR 1100TL, SOFAR 1600TL, SOFAR 2200TL and SOFAR 2700TL, since it is same as in hardware and just power derated by software.</p> | | | | | | | | |

Under frequency

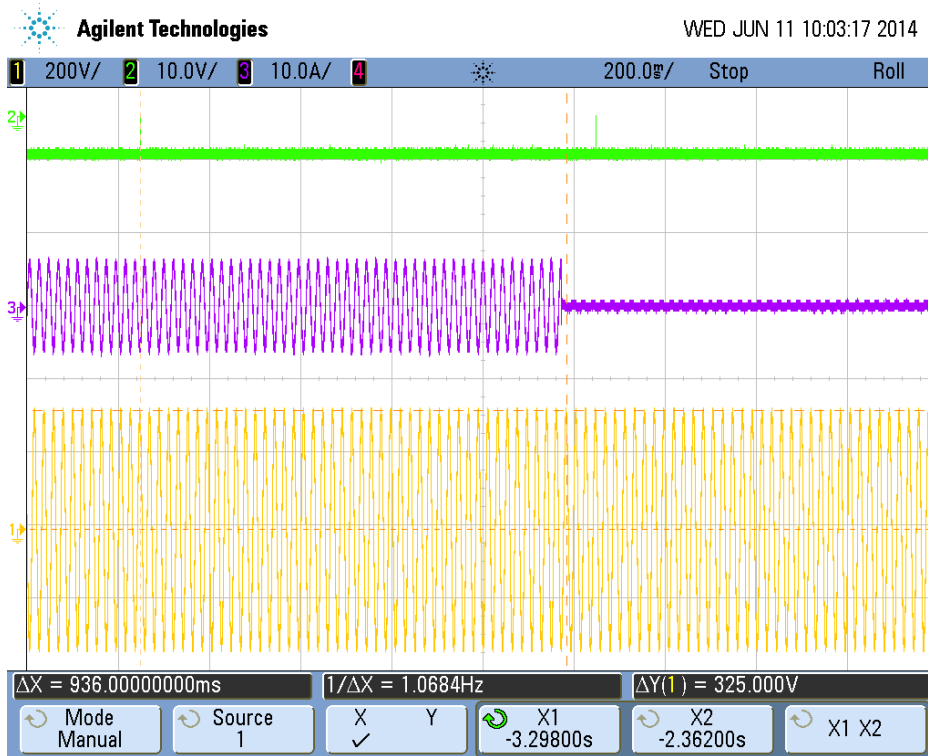

Over frequency

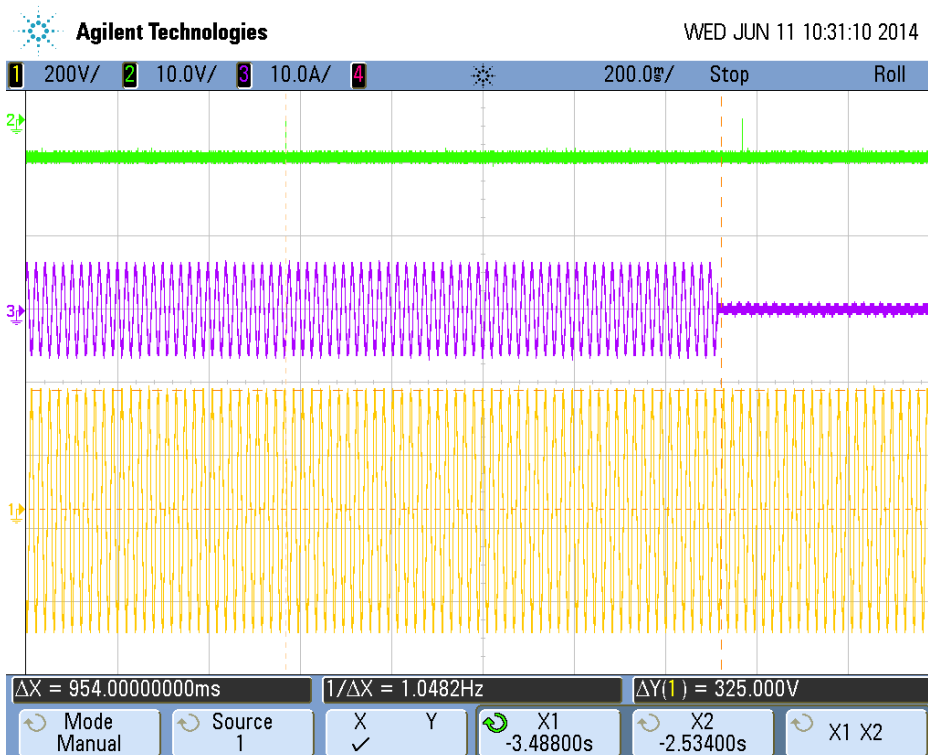

| 4.3.2. Loss of Mains according DIN V VDE V 0126-1-1:2006-02 | | | P |
|--|---|--|--|
| Test conditions | Frequency 50+/-0,1Hz U _N = 230+/-3Vac Distortion factor of chokes <2% Quality Q>2 | | |
| Disconnection limit | 5s | | |
| Output power | Min. ~25% disconnect time [ms] | Medium ~50% disconnect time [ms] | Max. ~100% disconnect time [ms] |
| Osc. Parameter | | | |
| - 5% | 0,158 | 0,204 | 0,180 |
| - 4% | 0,146 | 0,128 | 0,071 |
| - 3% | 0,202 | 0,108 | 0,104 |
| - 2% | 0,235 | 0,384 | 0,391 |
| - 1% | 0,420 | 0,398 | 0,452 |
| 0 % | 0,489 | 0,378 | 0,468 |
| +1 % | 0,422 | 0,431 | 0,485 |
| +2 % | 0,130 | 0,115 | 0,109 |
| +3 % | 0,190 | 0,202 | 0,111 |
| +4 % | 0,167 | 0,203 | 0,140 |
| +5 % | 0,170 | 0,048 | 0,100 |
| Parameter at 0% | L=120,02 mH R=76,12 Ω C=84,66 uF | L=59,48 mH R=37,84 Ω C=169,75 uF | L=29,87 mH R=18,93 Ω C=338,59 uF |
| <p>Note: The oscilloscope pictures below show the measured worst case disconnection times. The tests had been performed on the SOFAR 3000TL is valid for the SOFAR 1100TL, SOFAR 1600TL, SOFAR 2200TL and SOFAR 2700TL, since it is same as in hardware and just power derated by software.</p> | | | |

25% Power

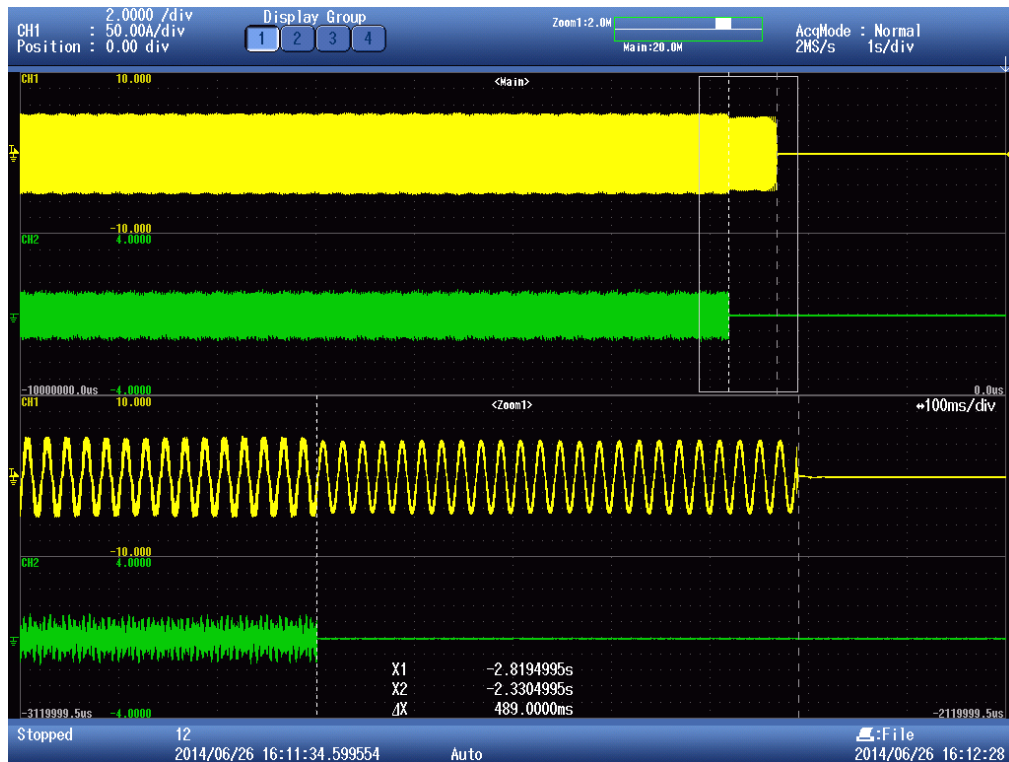

50% Power



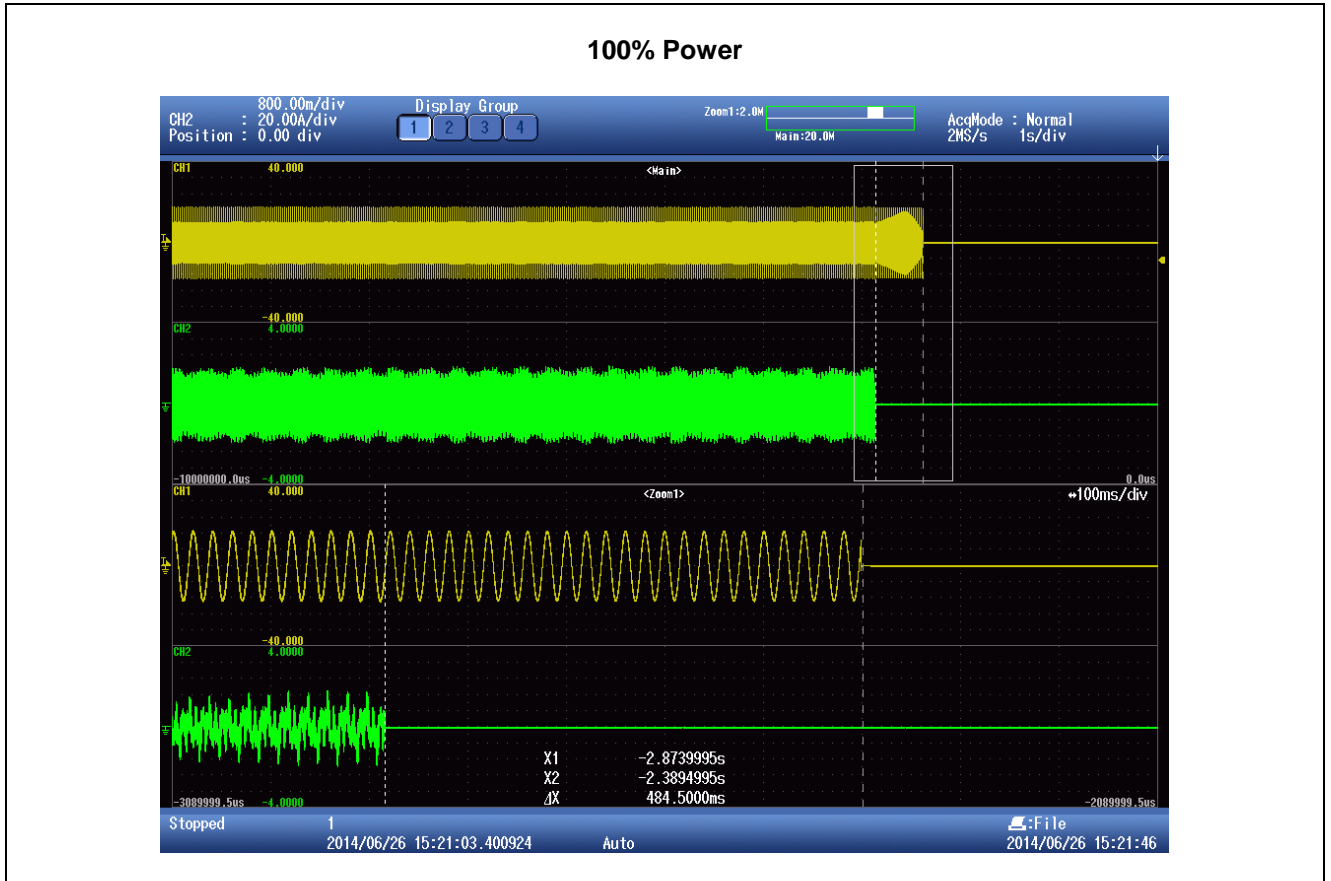

| 5.1 Harmonic current emission (EN 61000-3-2) (SOFAR 1100TL) | | | | P |
|--|-----------------------|------------------|--------------|-----------------------------|
| Watts [kW] | | 1,017 | | |
| Vrms [V] | | 230,07 | | |
| Arms [A] | | 4,419 | | |
| Frequency [Hz] | | 50,00 | | |
| THD [%] | | 1,83 | | |
| Harmonics | Current Magnitude [A] | % of Fundamental | Phase | Harmonic Current Limits [%] |
| 1st | 4,418 | -- | Single Phase | N/A |
| 2nd | 0,002 | 0,036 | Single Phase | 1,08 |
| 3rd | 0,080 | 1,799 | Single Phase | 2,3 |
| 4th | 0,001 | 0,032 | Single Phase | N/A |
| 5th | 0,010 | 0,224 | Single Phase | 1,14 |
| 6th | 0,001 | 0,032 | Single Phase | N/A |
| 7th | 0,006 | 0,140 | Single Phase | 0,77 |
| 8th | 0,002 | 0,036 | Single Phase | N/A |
| 9th | 0,004 | 0,091 | Single Phase | 0,4 |
| 10th | 0,002 | 0,043 | Single Phase | N/A |
| 11th | 0,003 | 0,059 | Single Phase | 0,33 |
| 12th | 0,002 | 0,043 | Single Phase | N/A |
| 13th | 0,002 | 0,045 | Single Phase | 0,21 |
| 14th | 0,002 | 0,041 | Single Phase | N/A |
| 15th | 0,002 | 0,041 | Single Phase | N/A |
| 16th | 0,002 | 0,034 | Single Phase | N/A |
| 17th | 0,002 | 0,034 | Single Phase | N/A |
| 18th | 0,001 | 0,029 | Single Phase | N/A |
| 19th | 0,002 | 0,036 | Single Phase | N/A |
| 20th | 0,001 | 0,032 | Single Phase | N/A |
| 21th | 0,002 | 0,048 | Single Phase | N/A |
| 22th | 0,001 | 0,025 | Single Phase | N/A |
| 23th | 0,002 | 0,034 | Single Phase | N/A |
| 24th | 0,001 | 0,023 | Single Phase | N/A |
| 25th | 0,002 | 0,041 | Single Phase | N/A |
| 26th | 0,001 | 0,018 | Single Phase | N/A |
| 27th | 0,002 | 0,034 | Single Phase | N/A |
| 28th | 0,001 | 0,023 | Single Phase | N/A |
| 29th | 0,002 | 0,041 | Single Phase | N/A |
| 30th | 0,001 | 0,014 | Single Phase | N/A |
| 31th | 0,001 | 0,032 | Single Phase | N/A |
| 32th | 0,001 | 0,018 | Single Phase | N/A |
| 33th | 0,002 | 0,036 | Single Phase | N/A |
| 34th | 0,001 | 0,014 | Single Phase | N/A |
| 35th | 0,001 | 0,032 | Single Phase | N/A |
| 36th | 0,001 | 0,014 | Single Phase | N/A |
| 37th | 0,002 | 0,036 | Single Phase | N/A |
| 38th | 0,001 | 0,016 | Single Phase | N/A |
| 39th | 0,001 | 0,029 | Single Phase | N/A |
| 40th | 0,001 | 0,014 | Single Phase | N/A |
| Note: The tests should be based on the limits of the EN61000-3-2 for less than 16A and on EN 61000-3-12 for more than 16A. | | | | |

| 5.1 Harmonic current emission (EN 61000-3-2) (SOFAR 3000TL) | | | | P |
|---|-----------------------|------------------|--------------|-----------------------------|
| Watts [kW] | | 2,804 | | |
| Vrms [V] | | 229,99 | | |
| Arms [A] | | 12,189 | | |
| Frequency [Hz] | | 50,00 | | |
| THD [%] | | 1,38 | | |
| Harmonics | Current Magnitude [A] | % of Fundamental | Phase | Harmonic Current Limits [%] |
| 1st | 12,188 | -- | Single Phase | N/A |
| 2nd | 0,008 | 0,066 | Single Phase | 1,08 |
| 3rd | 0,158 | 1,296 | Single Phase | 2,3 |
| 4th | 0,006 | 0,051 | Single Phase | N/A |
| 5th | 0,032 | 0,259 | Single Phase | 1,14 |
| 6th | 0,003 | 0,025 | Single Phase | N/A |
| 7th | 0,014 | 0,113 | Single Phase | 0,77 |
| 8th | 0,003 | 0,025 | Single Phase | N/A |
| 9th | 0,005 | 0,044 | Single Phase | 0,4 |
| 10th | 0,004 | 0,034 | Single Phase | N/A |
| 11th | 0,006 | 0,048 | Single Phase | 0,33 |
| 12th | 0,004 | 0,030 | Single Phase | N/A |
| 13th | 0,012 | 0,099 | Single Phase | 0,21 |
| 14th | 0,004 | 0,033 | Single Phase | N/A |
| 15th | 0,010 | 0,084 | Single Phase | N/A |
| 16th | 0,003 | 0,026 | Single Phase | N/A |
| 17th | 0,013 | 0,106 | Single Phase | N/A |
| 18th | 0,002 | 0,020 | Single Phase | N/A |
| 19th | 0,014 | 0,113 | Single Phase | N/A |
| 20th | 0,003 | 0,021 | Single Phase | N/A |
| 21th | 0,015 | 0,120 | Single Phase | N/A |
| 22th | 0,002 | 0,015 | Single Phase | N/A |
| 23th | 0,014 | 0,112 | Single Phase | N/A |
| 24th | 0,002 | 0,013 | Single Phase | N/A |
| 25th | 0,013 | 0,109 | Single Phase | N/A |
| 26th | 0,002 | 0,016 | Single Phase | N/A |
| 27th | 0,013 | 0,107 | Single Phase | N/A |
| 28th | 0,002 | 0,014 | Single Phase | N/A |
| 29th | 0,012 | 0,098 | Single Phase | N/A |
| 30th | 0,001 | 0,011 | Single Phase | N/A |
| 31th | 0,011 | 0,088 | Single Phase | N/A |
| 32th | 0,001 | 0,010 | Single Phase | N/A |
| 33th | 0,009 | 0,077 | Single Phase | N/A |
| 34th | 0,001 | 0,010 | Single Phase | N/A |
| 35th | 0,009 | 0,075 | Single Phase | N/A |
| 36th | 0,001 | 0,009 | Single Phase | N/A |
| 37th | 0,008 | 0,065 | Single Phase | N/A |
| 38th | 0,001 | 0,011 | Single Phase | N/A |
| 39th | 0,008 | 0,063 | Single Phase | N/A |
| 40th | 0,001 | 0,010 | Single Phase | N/A |

Note:
The tests should be based on the limits of the EN61000-3-2 for less than 16A and on EN 61000-3-12 for more than 16A.
The tests had been performed on the SOFAR 1100TL and SOFAR 3000TL are valid for the SOFAR 1600TL, SOFAR 2200TL and SOFAR 2700TL, since it is same as in hardware and just power derated by software.

| 5.1 Voltage fluctuation and flicker | | | | P |
|-------------------------------------|---|----------|----------------------|-------------------------|
| Test conditions | Maximum permissible voltage fluctuation (expressed as a percentage of nominal voltage at 100 % power) and flicker as per EN 61000-3-3 | | | |
| | Starting | Stopping | Running | |
| Limit | 3,3% | 3,3% | P _{st} =1,0 | P _{It} =0,65 |
| Test value | See below | | | |
| SOFAR 1100TL | | | | |
| No. | dc[%] | dmax[%] | d(t)[ms] | Pst |
| 1 | 0.00 | 0.00 | 0.00 | 0.07 |
| 2 | 0.00 | 0.00 | 0.00 | 0.07 |
| 3 | 0.00 | 0.00 | 0.00 | 0.07 |
| 4 | 0.00 | 0.00 | 0.00 | 0.07 |
| 5 | 0.00 | 0.00 | 0.00 | 0.07 |
| 6 | 0.00 | 0.00 | 0.00 | 0.07 |
| 7 | 0.00 | 0.00 | 0.00 | 0.07 |
| 8 | 0.00 | 0.00 | 0.00 | 0.07 |
| 9 | 0.00 | 0.00 | 0.00 | 0.07 |
| 10 | 0.00 | 0.00 | 0.00 | 0.07 |
| 11 | 0.00 | 0.00 | 0.00 | 0.07 |
| 12 | 0.00 | 0.00 | 0.00 | 0.07 |
| | | | | P _{It} 0.07 |
| SOFAR 3000TL | | | | |
| No. | dc[%] | dmax[%] | d(t)[ms] | Pst |
| 1 | 0.00 | 0.00 | 0.00 | 0.07 |
| 2 | 0.00 | 0.00 | 0.00 | 0.07 |
| 3 | 0.00 | 0.00 | 0.00 | 0.07 |
| 4 | 0.00 | 0.00 | 0.00 | 0.07 |
| 5 | 0.00 | 0.00 | 0.00 | 0.07 |
| 6 | 0.00 | 0.00 | 0.00 | 0.07 |
| 7 | 0.00 | 0.00 | 0.00 | 0.07 |
| 8 | 0.00 | 0.00 | 0.00 | 0.07 |
| 9 | 0.00 | 0.00 | 0.00 | 0.07 |
| 10 | 0.00 | 0.00 | 0.00 | 0.07 |
| 11 | 0.00 | 0.00 | 0.00 | 0.07 |
| 12 | 0.00 | 0.00 | 0.00 | 0.07 |
| | | | | P _{It} 0.07 |



Note:

*The stationary deviance of $d_c\%$ is bigger than the dynamic deviance of d_{max} at starting and stopping.

Mains Impedance according EN61000-3-3: $R_{max} = 0,24 \Omega$; $jX_{max} = 0,15\Omega @ 50Hz$ ($|Z_{max}| = 0,283\Omega$)

Bei Einphasigen Invertern Z_{max} sowie R_n und jx_n angeben $R_n = 0,16\Omega$; $jX_n = 0,10\Omega$

Calculation of the maximum permissible grid impedance at the point of common coupling based on d_c :

$$Z_{max} = Z_{ref} * 3,3\% / d_c(P_n)$$

The tests should be based on the limits of the EN61000-3-3 for less than 16A and on EN 61000-3-11 for more than 16A.

The tests had been performed on the SOFAR 1100TL and SOFAR 3000TL are valid for the SOFAR 1600TL, SOFAR 2200TL and SOFAR 2700TL, since it is same as in hardware and just power derated by software.

| 5.2 Monitoring of DC-Injection | | | | P |
|---------------------------------|---|-------|-------|---|
| Protection limit | tested at three power levels limit 0,5% of $I_{AC,nom}$ | | | |
| Output power | ~25% | ~50% | ~100% | |
| SOFAR 1100TL | | | | |
| max. test value (phase L1) [mA] | -7 mA | -6 mA | -6 mA | |
| SOFAR 3000TL | | | | |
| max. test value (phase L1) [mA] | -9 mA | -9 mA | -8 mA | |

Diagram of permanent dc-injection: SOFAR 1100TL

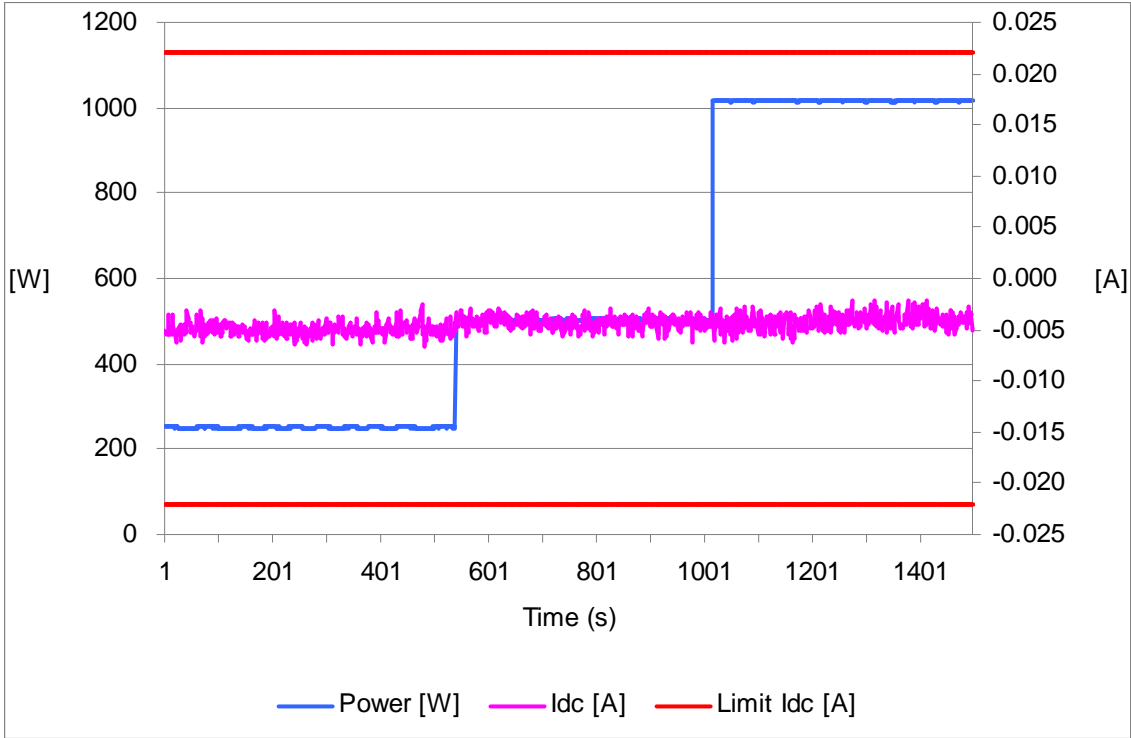

— Power [W]
 — Idc [A]
 — Limit Idc [A]

Diagram of permanent dc-injection: SOFAR 3000TL

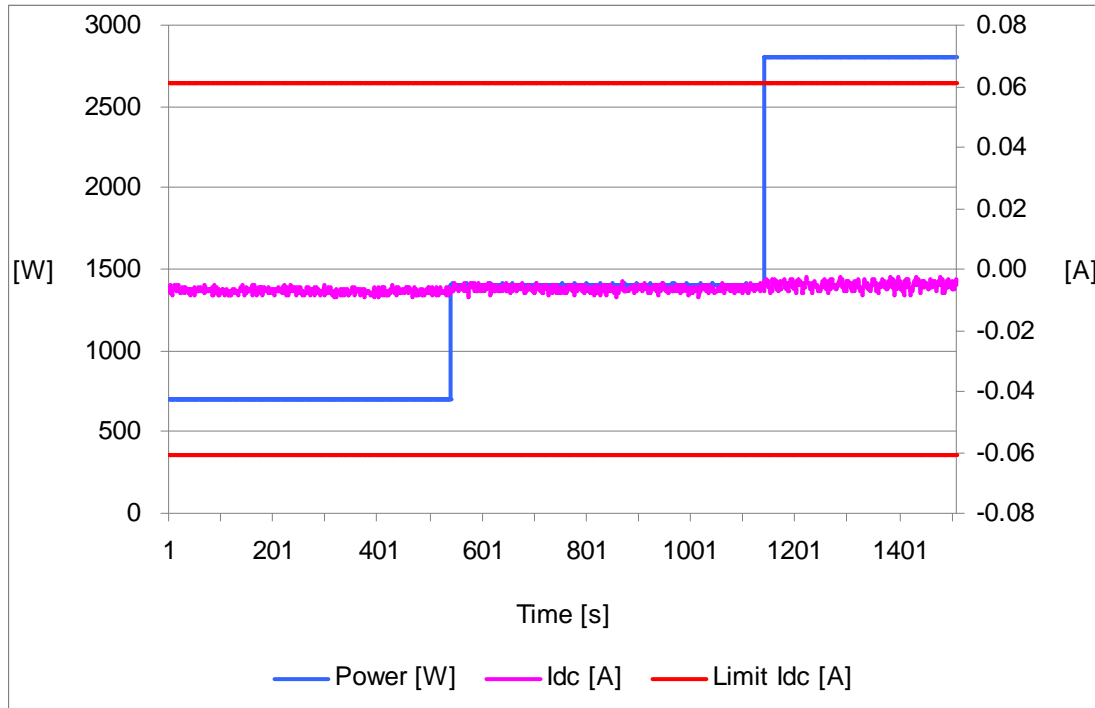

Note:

Testing must be performed according to WI 10.4.-03.doc rev D. The internal temperature of the EUT must be stabilized. No temperature drift of more than 2K within 1 hour is allowed.

The tests had been performed on the SOFAR 1100TL and SOFAR 3000TL are valid for the SOFAR 1600TL, SOFAR 2200TL and SOFAR 2700TL, since it is same as in hardware and just power derated by software.

| 5.3 Power factor | | | | | P | |
|--|--|---------------------------|--------|--------|--------|--------|
| SOFAR 1100TL | | | | | | |
| Test conditions | | U _{input} = 400V | | | | |
| Output power | | ~20% | ~40% | ~60% | ~80% | ~100% |
| Test voltage | | | | | | |
| 210V | | 0,994c | 0,998c | 0,999c | 0,999c | 0,999c |
| 230V | | 0,991c | 0,998c | 0,999c | 0,999c | 0,999c |
| 250V | | 0,987c | 0,997c | 0,999c | 0,999c | 0,999c |
| SOFAR 3000TL | | | | | | |
| Test conditions | | U _{input} = 450V | | | | |
| Output power | | ~20% | ~40% | ~60% | ~80% | ~100% |
| Test voltage | | | | | | |
| 210V | | 0,998c | 0,999c | 0,999c | 0,999c | 0,999c |
| 230V | | 0,998c | 0,999c | 0,999c | 0,999c | 0,999c |
| 250V | | 0,997c | 0,999c | 0,999c | 0,999c | 0,999c |
| Note: | | | | | | |
| The power factor of the micro-generator at normal steady-state operating conditions across the statutory tolerance band of normal voltage shall be between 0,95 leading and 0,95 lagging, provided the output active power of the micro-generator is above 20% the rated output of the unit. | | | | | | |
| The tests had been performed on the SOFAR 1100TL and SOFAR 3000TL are valid for the SOFAR 1600TL, SOFAR 2200TL and SOFAR 2700TL, since it is same as in hardware and just power derated by software. | | | | | | |

Annex 1

EMC Test Report



ATTESTATION of conformity with European Directives

Attestation Number: 1488AB0508N005R1001
 Product: PV Grid Inverter
 Brand Name: 
 Model: SOFAR 3000TL, SOFAR 1100TL, SOFAR 2200TL
 Additional Model: SOFAR 1600TL, SOFAR 2700TL
 Applicant: Shenzhen SOFARSOLAR Co., Ltd.
 Address: 3A-1, Huake Building, East Technology Park, Qiaoxiang Road, Nanshan District, Shenzhen, China.
 Technical Characteristics: DC Input: DC 110 - 380V Max. 10A For SOFAR 1100TL;
 DC Input: DC 165 - 380V Max. 10A For SOFAR 1600TL ;
 DC Input: DC 170 - 450V Max. 13A For SOFAR 2200TL;
 DC Input: DC 210 - 450V Max. 13A For SOFAR 2700TL;
 DC Input: DC 230 - 450V Max. 13A For SOFAR 3000TL
 Output: AC 230V, 50/60Hz, Power: 1000W / 1500W / 2000W / 2500W / 2800W
 Output Voltage/Current: SOFAR 1100TL:230V/4.5A; SOFAR 1600TL:230V/7.0A;
 SOFAR 2200TL:230V/9.5A; SOFAR 2700TL:230V/11.5A; SOFAR 3000TL:230V/13.0A

The submitted sample of the above equipment has been tested for CE marking according to following European Directive and standards:

- Electromagnetic Compatibility Directive 2004/108/EC

| Standards | Report Number | Report date |
|---|----------------|---------------|
| EN 61000-6-3:2007 + A1:2011 EN 61000-3-2:2006 + A1 :2009 + A2:2009 EN 61000-3-3:2013 EN 61000-6-2:2005 | CE140508N005R1 | Jul. 21, 2014 |

The referred test report(s) show that the product complies with standard(s) recognized as giving presumption of compliance with the essential requirements in the specified European Directive.

This verification does not imply assessment of the production of the product. The CE marking may be affixed if all relevant and effective European Directives with CE are applicable.



Supervisor
EMC Department

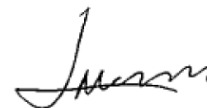

Name: Madison Luo
Date: Jul. 21, 2014

This document shall not be reproduced, except in full, without the written approval of
Bureau Veritas Shenzhen Co., Ltd.

Information given in this document is related to the tested specimen of the described electrical sample.

Bureau Veritas Shenzhen Co., Ltd.
Dongguan Branch

No. 34, Chenwulu Section, Guantai Rd.,
Houjie Town, Dongguan City,
Guangdong 523942, China

Tel.: +86 769 8593 5656
Fax: +86 769 8593 1080
Email: customerservice.dg@cn.bureauveritas.com

TEST REPORT

| | | |
|---|--|--|
| Applicant | Shenzhen SOFARSOLAR Co., Ltd. | |
| Address | 3A-1, Huake Building, East Technology Park, Qiaoxiang Road, Nanshan District, Shenzhen, China. | |
| Manufacturer or Supplier | Shenzhen SOFARSOLAR Co., Ltd. |  |
| Address | 3A-1, Huake Building, East Technology Park, Qiaoxiang Road, Nanshan District, Shenzhen, China. | |
| Product | PV grid-interactive inverter | |
| Brand Name |  | |
| Model | SOFAR 3000TL, SOFAR 1100TL, SOFAR 2200TL | |
| Additional Model & Model Difference | SOFAR 1600TL, SOFAR 2700TL See item 2.1 | |
| Date of tests | May 08, 2014 ~ Jun. 30, 2014 | |
| <p>The submitted sample of the above equipment has been tested for according to following European Directive - Electromagnetic directive 2004/108/EC and the tests have been carried out according to the requirements of the following standards:</p> <ul style="list-style-type: none"> <input checked="" type="checkbox"/> EN 61000-6-3:2007 + A1:2011 <input checked="" type="checkbox"/> EN 61000-3-2:2006 + A1:2009 + A2:2009 <input checked="" type="checkbox"/> EN 61000-3-3:2013 <input checked="" type="checkbox"/> EN 61000-6-2:2005 | | |
| <p>CONCLUSION: The submitted sample was found to <u>COMPLY</u> with the test requirement</p> | | |
| <p>Tested by Breeze Jiang Project Engineer / EMC Department</p> | | <p>Approved by Madison Luo Manager / EMC Department</p> |
|  | |  |
| | | <p>Date: Jul. 21, 2014</p> |
| <p><small>This report is for your exclusive use. Any copying or replication of this report to or for any other person or entity, or use of our name or trademark, is permitted only with our prior written permission. This report sets forth our findings solely with respect to the test samples identified herein. The results set forth in this report are not indicative or representative of the quality or characteristics of the lot from which a test sample was taken or any similar or identical product unless specifically and expressly noted. Our report includes all of the tests requested by you and the results thereof based upon the information that you provided to us. You have 60 days from date of issuance of this report to notify us of any material error or omission caused by our negligence, provided, however, that such notice shall be in writing and shall specifically address the issue you wish to raise. A failure to raise such issue within the prescribed time shall constitute your unqualified acceptance of the completeness of this report, the tests conducted and the correctness of the report contents. Unless specific mention, the uncertainty of measurement has been explicitly taken into account to declare the compliance or non-compliance to the specification</small></p> | | |

Bureau Veritas Shenzhen Co., Ltd.
Dongguan Branch

No. 34, Chenwulu Section, Guantai Rd., Houjie
Town, Dongguan City,
Guangdong 523942, China

Tel: +86 769 8593 5656
Fax: +86 769 8593 1080
Email: customerservice.dg@cn.bureauveritas.com



Table of Contents

| | |
|--|----|
| RELEASE CONTROL RECORD | 5 |
| 1 SUMMARY OF TEST RESULTS | 6 |
| 1.1 MEASUREMENT UNCERTAINTY | 8 |
| 2 GENERAL INFORMATION | 9 |
| 2.1 GENERAL DESCRIPTION OF EUT | 9 |
| 2.2 DESCRIPTION OF TEST MODES | 11 |
| 2.3 GENERAL DESCRIPTION OF APPLIED STANDARDS | 12 |
| 2.4 DESCRIPTION OF SUPPORT UNITS | 12 |
| 3 EMISSION TEST | 13 |
| 3.1 CONDUCTED EMISSION MEASUREMENT | 13 |
| 3.1.1 LIMITS OF CONDUCTED EMISSION MEASUREMENT | 13 |
| 3.1.2 TEST INSTRUMENTS | 13 |
| 3.1.3 TEST PROCEDURE | 14 |
| 3.1.4 DEVIATION FROM TEST STANDARD | 14 |
| 3.1.5 TEST SETUP | 15 |
| 3.1.6 EUT OPERATING CONDITIONS | 15 |
| 3.1.7 TEST RESULTS | 16 |
| 3.2 RADIATED EMISSION MEASUREMENT | 18 |
| 3.2.1 LIMITS OF RADIATED EMISSION MEASUREMENT | 18 |
| 3.2.2 TEST INSTRUMENTS | 19 |
| 3.2.3 TEST PROCEDURE | 20 |
| 3.2.4 DEVIATION FROM TEST STANDARD | 21 |
| 3.2.5 TEST SETUP | 22 |
| 3.2.6 EUT OPERATING CONDITIONS | 22 |
| 3.2.7 TEST RESULTS | 23 |
| 3.3 HARMONICS CURRENT MEASUREMENT (<16A) | 25 |
| 3.3.1 LIMITS OF HARMONICS CURRENT MEASUREMENT | 25 |
| 3.3.2 TEST INSTRUMENTS | 26 |
| 3.3.3 TEST PROCEDURE | 26 |
| 3.3.4 DEVIATION FROM TEST STANDARD | 27 |
| 3.3.5 TEST SETUP | 27 |
| 3.3.6 EUT OPERATING CONDITIONS | 27 |
| 3.3.7 TEST RESULTS | 28 |
| 3.4 VOLTAGE FLUCTUATION AND FLICKS MEASUREMENT | 32 |
| 3.4.1 LIMITS OF VOLTAGE FLUCTUATION AND FLICKS MEASUREMENT | 32 |
| 3.4.2 TEST INSTRUMENTS | 32 |
| 3.4.3 TEST PROCEDURE | 32 |
| 3.4.4 DEVIATION FROM TEST STANDARD | 33 |
| 3.4.5 TEST SETUP | 33 |
| 3.4.6 EUT OPERATING CONDITIONS | 33 |
| 3.4.7 TEST RESULTS | 34 |
| 4 IMMUNITY TEST | 36 |
| 4.1 GENERAL DESCRIPTION | 36 |

Bureau Veritas Shenzhen Co., Ltd.
Dongguan Branch

No. 34, Chenwulu Section, Guantai Rd., Houjie
Town, Dongguan City,
Guangdong 523942, China

Tel: +86 769 8593 5656
Fax: +86 769 8593 1080
Email: customerservice.dg@cn.bureauveritas.com



| | | |
|-------|--|----|
| 4.1.1 | GENERAL DESCRIPTION OF EN 61000-6-2 | 36 |
| 4.1.2 | PERFORMANCE CRITERIA | 37 |
| 4.1.3 | EUT OPERATING CONDITION | 37 |
| 4.2 | ELECTROSTATIC DISCHARGE IMMUNITY TEST (ESD) | 38 |
| 4.2.1 | TEST SPECIFICATION | 38 |
| 4.2.2 | TEST INSTRUMENTS | 38 |
| 4.2.3 | TEST PROCEDURE | 39 |
| 4.2.4 | DEVIATION FROM TEST STANDARD | 39 |
| 4.2.5 | TEST SETUP | 40 |
| 4.2.6 | TEST RESULTS | 41 |
| 4.3 | RADIATED, RADIO-FREQUENCY, ELECTROMAGNETIC FIELD IMMUNITY TEST (RS) | 42 |
| 4.3.1 | TEST SPECIFICATION | 42 |
| 4.3.2 | TEST INSTRUMENTS | 42 |
| 4.3.3 | TEST PROCEDURE | 43 |
| 4.3.4 | DEVIATION FROM TEST STANDARD | 43 |
| 4.3.5 | TEST SETUP | 44 |
| 4.3.6 | TEST RESULTS | 45 |
| 4.4 | ELECTRICAL FAST TRANSIENT/BURST IMMUNITY TEST (EFT) | 46 |
| 4.4.1 | TEST SPECIFICATION | 46 |
| 4.4.2 | TEST INSTRUMENTS | 46 |
| 4.4.3 | TEST PROCEDURE | 46 |
| 4.4.4 | DEVIATION FROM TEST STANDARD | 46 |
| 4.4.5 | TEST SETUP | 47 |
| 4.4.6 | TEST RESULTS | 48 |
| 4.5 | SURGE IMMUNITY TEST | 49 |
| 4.5.1 | TEST SPECIFICATION | 49 |
| 4.5.2 | TEST INSTRUMENTS | 49 |
| 4.5.3 | TEST PROCEDURE | 50 |
| 4.5.4 | DEVIATION FROM TEST STANDARD | 50 |
| 4.5.5 | TEST SETUP | 50 |
| 4.5.6 | TEST RESULTS | 51 |
| 4.6 | IMMUNITY TO CONDUCTED DISTURBANCES INDUCED BY RF FIELDS (CS) | 52 |
| 4.6.1 | TEST SPECIFICATION | 52 |
| 4.6.2 | TEST INSTRUMENTS | 52 |
| 4.6.3 | TEST PROCEDURE | 53 |
| 4.6.4 | DEVIATION FROM TEST STANDARD | 53 |
| 4.6.5 | TEST SETUP | 54 |
| 4.6.6 | TEST RESULTS | 55 |
| 4.7 | POWER FREQUENCY MAGNETIC FIELD IMMUNITY TEST | 56 |
| 4.7.1 | TEST SPECIFICATION | 56 |
| 4.7.2 | TEST INSTRUMENTS | 56 |
| 4.7.3 | TEST PROCEDURE | 56 |
| 4.7.4 | DEVIATION FROM TEST STANDARD | 56 |
| 4.7.5 | TEST SETUP | 57 |
| 4.7.6 | TEST RESULTS | 58 |
| 5 | PHOTOGRAPHS OF THE TEST CONFIGURATION | 59 |

Bureau Veritas Shenzhen Co., Ltd.
Dongguan Branch

No. 34, Chenwulu Section, Guantai Rd., Houjie
Town, Dongguan City,
Guangdong 523942, China

Tel: +86 769 8593 5656
Fax: +86 769 8593 1080
Email: customerservice.dg@cn.bureauveritas.com



Test Report No.: CE140508N005R1

| | | |
|---|---|----|
| 6 | APPENDIX A – MODIFICATIONS RECORDERS FOR ENGINEERING CHANGES TO THE EUT BY THE LAB | 66 |
|---|---|----|

Bureau Veritas Shenzhen Co., Ltd.
Dongguan Branch

No. 34, Chenwulu Section, Guantai Rd., Houjie
Town, Dongguan City,
Guangdong 523942, China

Tel: +86 769 8593 5656
Fax: +86 769 8593 1080
Email: customerservice.dg@cn.bureauveritas.com

Bureau Veritas Shenzhen Co., Ltd.
Dongguan Branch

No. 34, Chenwulu Section, Guantai Rd.,
Houjie Town, Dongguan City, Guangdong
523942, China
Page 38 of 127

Tel: +86 769 8593 5656
Fax: +86 769 8599 1080
Email: customerservice.dg@cn.bureauveritas.com
TEST REPORT EN 50438 VER.1

RELEASE CONTROL RECORD

| ISSUE NO. | REASON FOR CHANGE | DATE ISSUED |
|----------------|---|---------------|
| CE140508N005 | Original release | Jul. 10, 2014 |
| CE140508N005R1 | Based on the original report CE140508N005 change power supply information, model and technical characteristics. | Jul. 21, 2014 |

Bureau Veritas Shenzhen Co., Ltd.
Dongguan Branch

No. 34, Chenwulu Section, Guantai Rd., Houjie
Town, Dongguan City,
Guangdong 523942, China

Tel: +86 769 8593 5656
Fax: +86 769 8593 1080
Email: customerservice.dg@cn.bureauveritas.com

Page 5 of 66

Report Version 1

Bureau Veritas Shenzhen Co., Ltd.
Dongguan Branch

No. 34, Chenwulu Section, Guantai Rd.,
Houjie Town, Dongguan City, Guangdong
523942, China
Page 39 of 127

Tel: +86 769 8593 5656
Fax: +86 769 8599 1080
Email: customerservice.dg@cn.bureauveritas.com
TEST REPORT EN 50438 VER.1



1 SUMMARY OF TEST RESULTS

The EUT has been tested according to the following specifications:

| EMISSION | | | |
|--|-----------------------------------|--------|--|
| Standard | Test Type | Result | Remarks |
| EN61000-6-3:2007+ A1:2011 | Conducted test | PASS | Meets requirement limit Minimum passing margin is -3.00 dB at 0.36094MHz |
| | Radiated test (30MHz~1GHz) | PASS | Meets limits minimum passing margin is -5.08 dB at 191.02MHz |
| EN 61000-3-2:2006 + A1:2009 + A2:2009 | Harmonic current emissions | PASS | Meets the requirements. |
| EN 61000-3-3:2013 | Voltage fluctuations & flicker | PASS | Meets the requirements. |

| IMMUNITY (EN 61000-6-2:2005) | | | |
|--------------------------------------|---|--------|--|
| Standard | Test Type | Result | Remarks |
| IEC 61000-4-2:2008 | Electrostatic discharge immunity test | PASS | Electrostatic Discharge – ESD: 8kV Air discharge, 4kV Contact discharge, Performance Criterion A |
| IEC 61000-4-3:2005 + A1:2007+A2:2010 | Radiated, radio-frequency, electromagnetic field immunity test | PASS | Radio-Frequency Electromagnetic Field Susceptibility Test – RS: 80-1000 MHz, 10V/m, 80% AM (1kHz), 1400-2000 MHz, 3V/m, 80% AM (1kHz) 2000-2700 MHz, 1V/m, 80% AM (1kHz) Performance Criterion A |
| IEC 61000-4-4:2012 | Electrical fast transient / burst immunity test. | PASS | Electrical Fast Transient/Burst - EFT AC Power line: 2kV, DC Power line: 2kV, Performance Criterion A |
| IEC 61000-4-5:2005 | Surge immunity test | PASS | Surge Immunity Test: 1.2/50 us Open Circuit Voltage, 8 /20 us Short Circuit Current, AC Power Line: line to line 1 kV, Line to earth 2kV , DC Power Line: line to line 0.5 kV Performance Criterion B |
| IEC 61000-4-6:2008 | Immunity to conducted disturbances, induced by radio-frequency fields | PASS | Conducted Radio Frequency Disturbances Test – CS: 0.15-80 MHz, 10Vrms, 80% AM, 1kHz, Performance Criterion A |
| IEC 61000-4-8:2009 | Power frequency magnetic field immunity test. | PASS | Power Frequency Magnetic Field Test, 50 Hz / 60Hz, 30A/m, Performance Criterion A |

1.1 MEASUREMENT UNCERTAINTY

Where relevant, the following measurement uncertainty levels have been estimated for tests performed on the EUT as specified in CISPR 16-4-2:

This uncertainty represents an expanded uncertainty expressed at approximately the 95% confidence level using a coverage factor of $k=2$.

| MEASUREMENT | FREQUENCY | UNCERTAINTY |
|---|-----------------|-------------|
| Mains Terminal Disturbance Voltage Test | 0.15MHz ~ 30MHz | +/-2.67 dB |
| Radiated Disturbance Test | 30MHz ~ 1000MHz | +/-4.36 dB |



2 GENERAL INFORMATION

2.1 GENERAL DESCRIPTION OF EUT

| | |
|---------------------------------|--|
| PRODUCT | PV Grid Inverter |
| MODEL NO. | SOFAR 3000TL, SOFAR 1100TL, SOFAR 2200TL |
| ADDITIONAL MODEL | SOFAR 1600TL, SOFAR 2700TL |
| POWER SUPPLY | DC Input: DC 110 - 380V Max. 10A For SOFAR 1100TL; DC Input: DC 165 - 380V Max. 10A For SOFAR 1600TL ; DC Input: DC 170 - 450V Max. 13A For SOFAR 2200TL; DC Input: DC 210 - 450V Max. 13A For SOFAR 2700TL; DC Input: DC 230 - 450V Max. 13A For SOFAR 3000TL Output: AC 230V, 50/60Hz, Power: 1000W / 1500W / 2000W / 2500W / 2800W Output Voltage/Current: SOFAR 1100TL:230V/4.5A; SOFAR 1600TL:230V/7.0A; SOFAR 2200TL:230V/9.5A; SOFAR 2700TL:230V/11.5A; SOFAR 3000TL:230V/13.0A |
| SOFTWARE VERSION | V1.00 |
| HARDWARE VERSION | V1.00 |
| THE HIGHEST OPERATING FREQUENCY | Below 108MHz |
| DATA CABLE SUPPLIED | DC Cable: Shielded; Detachable 1.8m; AC Cable: Shielded; Detachable 1.8m |

NOTE:

1. This report CE140508N005R1 supersedes the previous one with the report number CE140508N005 dated on Jul. 10, 2014.
2. For the test results, the EUT had been tested with all conditions. But only the worst case was showed in test report.
3. For a more detailed features description, please refer to the manufacturer's specifications or the User's Manual.
4. RS485 port on the product is for client to collect data, according to client requirements, no need to test.
5. All models shell include red, blue, white and other colors. All models of DC switch and WIFI module is optional accessories, optional installation according to the need of client.

Bureau Veritas Shenzhen Co., Ltd.
Dongguan Branch

No. 34, Chenwulu Section, Guantai Rd., Houjie
Town, Dongguan City,
Guangdong 523942, China

Tel: +86 769 8593 5656
Fax: +86 769 8593 1080
Email: customerservice.dg@cn.bureauveritas.com

6. This is a series of PV Grid Inverter with the same as in hardware except the amount of BUS capacitor, inverter inductor, Boost and IGBT component and DC switch are different. Identical in software the output power just adjusted by software; models SOFAR 3000TL, SOFAR 1100TL, SOFAR 2200TL are selected to test. full test was performed for the model SOFAR 3000TL, and partial test for the models SOFAR 1100TL, SOFAR 2200TL.

| | | | | | |
|----------------------------------|------------------|--------------|-------------------|--------------|--------------|
| Ratings | SOFAR 1100TL | SOFAR 1600TL | SOFAR 2200TL | SOFAR 2700TL | SOFAR 3000TL |
| MPP DC voltage range [V] | 110-380 | 165-380 | 170-450 | 210-450 | 230-450 |
| Input DC voltage range [V] | 90-400, max. 450 | | 100-480, max. 500 | | |
| Input DC current [A] | 10 | | 13 | | |
| Output AC voltage [V] | 230V, 50Hz | | | | |
| Output AC current [A] | 4,5 | 7,0 | 9,5 | 11,5 | 13,0 |
| Output power [W] | 1000 | 1500 | 2000 | 2500 | 2800 |

7. Model Difference:

| Difference: | SOFAR 3000TL | SOFAR 2700TL | SOFAR 2200TL | SOFAR 1600TL | SOFAR 1100TL |
|--|---------------------|---------------------|-----------------------|-----------------------|----------------------|
| Boost inductor | 1.9mH | 1.9mH | 1.9mH | 2.6mH | 2.6mH |
| Input sampling resistor (RP105,RP108 /RP189,RP109) | 200ohm / 7.5Kohm | 200ohm / 7.5Kohm | 200ohm / 7.5Kohm | 220ohm / 10Kohm | 220ohm / 10Kohm |
| Bus capacitor | 3pcs | 3pcs | 3pcs | 2pcs | 2pcs |
| Inverter inductor | 1.3mH | 1.5mH | 2.1mH | 2.3mH | 3.4mH |
| Output sampling resistor (RP118, RP119, RC18 /RP120, RP121,RC22) | 2Kohm,100ohm,100ohm | 2Kohm,100ohm,100ohm | 1.0Kohm,330ohm,330ohm | 1.0Kohm,200ohm,100ohm | 499ohm,200ohm,200ohm |



2.2 DESCRIPTION OF TEST MODES

The EUT was tested under the following modes' the final worst mode were marked in boldface and recorded in this report.

◆ For Conducted Emission Test

| Test Mode | TEST VOLTAGE | Model |
|-----------|--------------|---------------------|
| Full Load | DC 380V | SOFAR 2200TL |
| Full Load | DC 380V | SOFAR 1100TL |
| Full Load | DC 230V | SOFAR 3000TL |
| Full Load | DC 360V | |
| Full Load | DC 450V | |

◆ For Radiated Emission Test

| Test Mode | TEST VOLTAGE | Model |
|-----------|--------------|---------------------|
| Full Load | DC 380V | SOFAR 2200TL |
| Full Load | DC 380V | SOFAR 1100TL |
| Full Load | DC 230V | SOFAR 3000TL |
| Full Load | DC 360V | |
| Full Load | DC 450V | |

◆ For Harmonics and Flicker Tests

| Test Mode | TEST VOLTAGE | Model |
|-----------|--------------|---------------------|
| Full Load | DC 380V | SOFAR 1100TL |
| Full Load | DC 380V | SOFAR 3000TL |

◆ For Immunity Test

| Test Mode | TEST VOLTAGE | Model |
|-----------|--------------|---------------------|
| 10% Load | DC 300V | SOFAR 3000TL |



2.3 GENERAL DESCRIPTION OF APPLIED STANDARDS

The EUT has been tested and complied with the requirements of the following standards:

- EN 61000-6-3:2007 + A1:2011
- EN 61000-3-2:2006 + A1:2009 + A2:2009
- EN 61000-3-3:2013
- EN 61000-6-2:2005
- IEC 61000-4-2:2008
- IEC 61000-4-3:2005 + A1:2007 + A2:2010
- IEC 61000-4-4:2012
- IEC 61000-4-5:2005
- IEC 61000-4-6:2008
- IEC 61000-4-8:2009

Notes: The above IEC basic standards are applied with latest version if customer has no special requirement

2.4 DESCRIPTION OF SUPPORT UNITS

The EUT has been tested as an independent unit together with other necessary accessories or support units. The following support units or accessories were used to form a representative test configuration during the tests.

| NO. | PRODUCT | BRAND | MODEL NO. | SERIAL NO. | FCC ID |
|-----|-----------|--------|--------------|--------------|--------|
| 1 | DC Source | Chroma | 62150H-1000S | 62150EF00488 | N/A |

| NO. | SIGNAL CABLE DESCRIPTION OF THE ABOVE SUPPORT UNITS |
|-----|---|
| 1 | AC Line: Unshielded, Detachable 2.0m, DC Line: Unshielded, Detachable 2.0m; |



3 EMISSION TEST

3.1 CONDUCTED EMISSION MEASUREMENT

3.1.1 LIMITS OF CONDUCTED EMISSION MEASUREMENT

| FREQUENCY (MHz) | Class A (dBuV) | | Class B (dBuV) | |
|-----------------|----------------|---------|----------------|---------|
| | Quasi-peak | Average | Quasi-peak | Average |
| 0.15 - 0.5 | 79 | 66 | 66 - 56 | 56 - 46 |
| 0.50 - 5.0 | 73 | 60 | 56 | 46 |
| 5.0 - 30.0 | 73 | 60 | 60 | 50 |

- Note:**
- (1) The lower limit shall apply at the transition frequencies.
 - (2) The limit decreases in line with the logarithm of the frequency in the range of 0.15 to 0.50 MHz.
 - (3) All emanations from a class A/B digital device or system, including any network of conductors and apparatus connected thereto, shall not exceed the level of field strengths specified above.

3.1.2 TEST INSTRUMENTS

| Equipment | Manufacturer | Model No. | Serial No. | Last Cal. | Next Cal. |
|--------------------------|---------------|-----------------|------------|-------------|-------------|
| EMI Test Receiver | Rohde&Schwarz | ESCS30 | 100199 | May 17, 14 | May 16, 15 |
| Pulse Limiter | Rohde&Schwarz | ESH3-Z2 | 100168 | Oct. 12, 13 | Oct. 11, 14 |
| Artificial Mains Network | Rohde&Schwarz | ESH2-Z5 | 100071 | May 13, 14 | May 12, 15 |
| Test software | ADT | ADT_Cond_V7.3.7 | N/A | N/A | N/A |

- NOTE:**
1. The calibration interval of the above test instruments is 12 months and the calibrations are traceable to CEPREI/CHINA, GRGT/CHINA and NIM/CHINA.
 2. The test was performed in shielding room 843.



3.1.3 TEST PROCEDURE

- a. The EUT was placed 0.4 meters from the conducting wall of the shielded room with EUT being connected to the power mains through a line impedance stabilization network (LISN). Other support units were connected to the power mains through another LISN. The two LISNs provide 50 Ohm/ 50uH of coupling impedance for the measuring instrument.
- b. Both lines of the power mains connected to the EUT were checked for maximum conducted interference.
- c. The frequency range from 150 kHz to 30 MHz was searched. Emission levels under (Limit – 20dB) were not recorded.

3.1.4 DEVIATION FROM TEST STANDARD

No deviation



BUREAU
VERITAS Test Report No.: CE140508N005R1

3.1.5 TEST SETUP

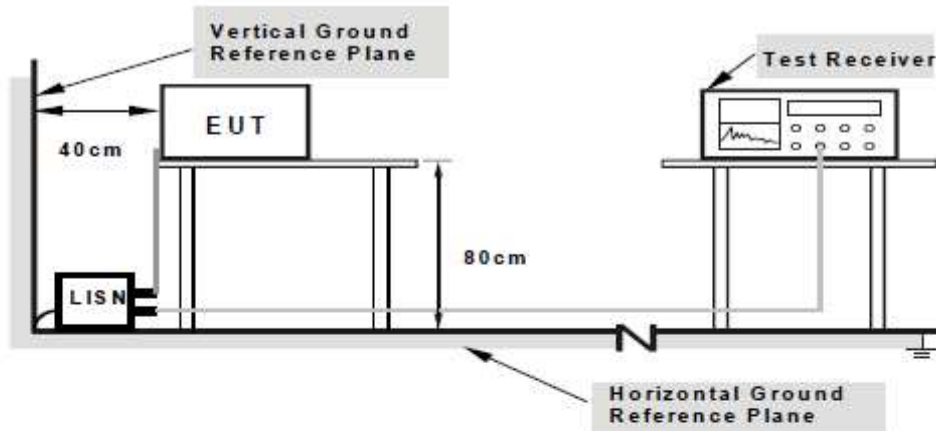

- Note: 1. Support units were connected to second LISN.
2. Both of LISNs (AMN) are 80cm from EUT and at least 80cm from other units and other metal planes support units.

3.1.6 EUT OPERATING CONDITIONS

- Turned on the power of all equipment.
- EUT was operated according to the type description in manufacturer's specifications or the User's Manual.

Bureau Veritas Shenzhen Co., Ltd.
Dongguan Branch

No. 34, Chenwulu Section, Guantai Rd., Houjie
Town, Dongguan City,
Guangdong 523942, China

Tel: +86 769 8593 5656
Fax: +86 769 8593 1080
Email: customerservice.dg@cn.bureauveritas.com

Page 15 of 66

Report Version 1

Bureau Veritas Shenzhen Co., Ltd.
Dongguan Branch

No. 34, Chenwulu Section, Guantai Rd.,
Houjie Town, Dongguan City, Guangdong
523942, China
Page 49 of 127

Tel: +86 769 8593 5656
Fax: +86 769 8599 1080
Email: customerservice.dg@cn.bureauveritas.com
TEST REPORT EN 50438 VER.1



BUREAU VERITAS Test Report No.: CE140508N005R1

3.1.7 TEST RESULTS

| | | | |
|--------------------------|-------------------|------------------|----------|
| TEST MODE | SOFAR 3000TL | 6dB BANDWIDTH | 9 kHz |
| | Grid Mode | | |
| TEST VOLTAGE | DC 360V | PHASE | Line (L) |
| ENVIRONMENTAL CONDITIONS | 23 deg. C, 42% RH | TESTED BY: Heise | |

| No | Freq. [MHz] | Corr. Factor (dB) | Reading Value [dB (uV)] | | Emission Level [dB (uV)] | | Limit [dB (uV)] | | Margin (dB) | |
|----|----------------|-------------------------|----------------------------|-------|-----------------------------|-------|--------------------|-------|----------------|--------|
| | | | Q.P. | AV. | Q.P. | AV. | Q.P. | AV. | Q.P. | AV. |
| 1 | 0.16172 | 5.20 | 48.57 | 45.49 | 53.77 | 50.69 | 65.38 | 55.38 | -11.60 | -4.68 |
| 2 | 0.27891 | 9.16 | 40.76 | 37.52 | 49.92 | 46.68 | 60.85 | 50.85 | -10.93 | -4.17 |
| 3 | 0.31797 | 9.23 | 39.58 | 36.34 | 48.81 | 45.57 | 59.76 | 49.76 | -10.95 | -4.19 |
| 4 | 0.36094 | 9.32 | 39.63 | 36.39 | 48.95 | 45.71 | 58.71 | 48.71 | -9.76 | -3.00 |
| 5 | 0.43906 | 9.47 | 36.61 | 34.20 | 46.08 | 43.67 | 57.08 | 47.08 | -11.00 | -3.41 |
| 6 | 4.25000 | 10.01 | 32.52 | 25.58 | 42.53 | 35.59 | 56.00 | 46.00 | -13.47 | -10.41 |

REMARKS: The emission levels of other frequencies were very low against the limit.

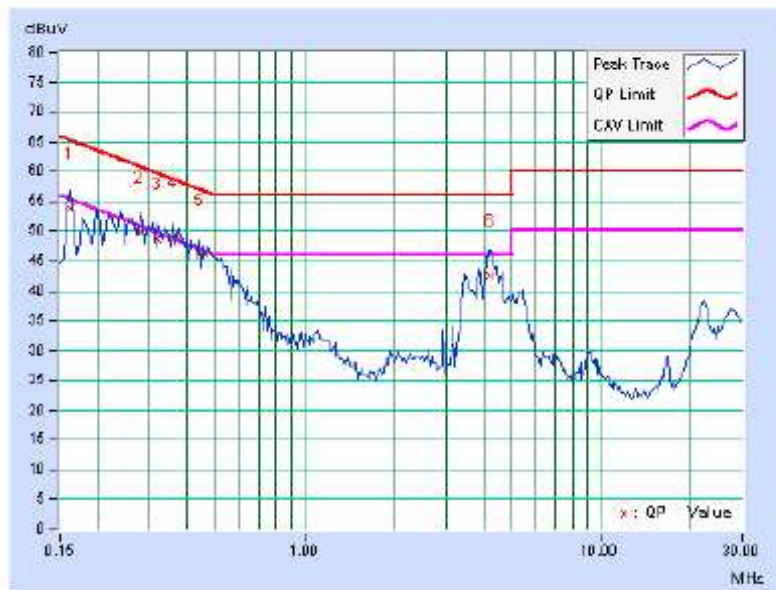

Bureau Veritas Shenzhen Co., Ltd.
Dongguan Branch

No. 34, Chenwulu Section, Guantai Rd., Houjie
Town, Dongguan City,
Guangdong 523942, China

Tel: +86 769 8593 5656
Fax: +86 769 8593 1080
Email: customerservice.dg@cn.bureauveritas.com

Page 16 of 66

Report Version 1

Bureau Veritas Shenzhen Co., Ltd.
Dongguan Branch

No. 34, Chenwulu Section, Guantai Rd.,
Houjie Town, Dongguan City, Guangdong
523942, China
Page 50 of 127

Tel: +86 769 8593 5656
Fax: +86 769 8599 1080
Email: customerservice.dg@cn.bureauveritas.com
TEST REPORT EN 50438 VER.1

| | | | |
|--------------------------|---------------------------|------------------|-------------|
| TEST MODE | SOFAR 3000TL Grid Mode | 6dB BANDWIDTH | 9 kHz |
| TEST VOLTAGE | DC 360V | PHASE | Neutral (N) |
| ENVIRONMENTAL CONDITIONS | 23 deg. C, 42% RH | TESTED BY: Heise | |

| No | Freq. [MHz] | Corr. Factor (dB) | Reading Value [dB (uV)] | | Emission Level [dB (uV)] | | Limit [dB (uV)] | | Margin (dB) | |
|----|----------------|-------------------------|----------------------------|---------|-----------------------------|-------|--------------------|-------|----------------|--------|
| | | | Q.P. | AV. | Q.P. | AV. | Q.P. | AV. | Q.P. | AV. |
| | | | 1 | 0.15781 | 4.85 | 47.50 | 43.90 | 52.35 | 48.75 | 65.58 |
| 2 | 0.28281 | 9.19 | 39.88 | 36.67 | 49.07 | 45.86 | 60.73 | 50.73 | -11.67 | -4.88 |
| 3 | 0.37656 | 9.35 | 38.15 | 35.11 | 47.50 | 44.46 | 58.35 | 48.35 | -10.85 | -3.89 |
| 4 | 0.43906 | 9.46 | 36.24 | 33.89 | 45.70 | 43.35 | 57.08 | 47.08 | -11.38 | -3.73 |
| 5 | 0.48203 | 9.54 | 35.42 | 33.03 | 44.96 | 42.57 | 56.30 | 46.30 | -11.35 | -3.74 |
| 6 | 4.22266 | 10.05 | 33.58 | 25.62 | 43.63 | 35.67 | 56.00 | 46.00 | -12.37 | -10.33 |

REMARKS: The emission levels of other frequencies were very low against the limit.

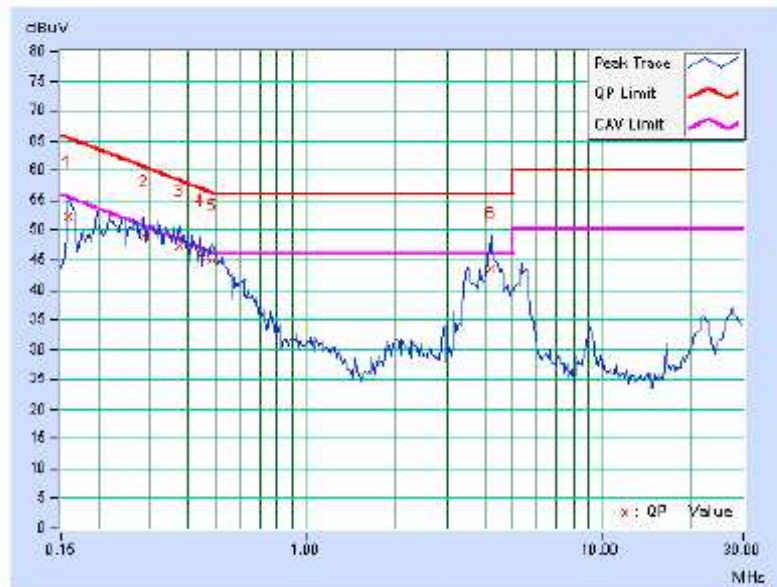



BUREAU VERITAS Test Report No.: CE140508N005R1

3.2 RADIATED EMISSION MEASUREMENT

3.2.1 LIMITS OF RADIATED EMISSION MEASUREMENT

TEST STANDARD: EN 61000-6-3

FOR FREQUENCY BELOW 1000 MHz

| FREQUENCY (MHz) | Class A (at 10m) | Class B (at 10m) |
|--------------------|------------------|------------------|
| | dBuV/m | dBuV/m |
| 30 – 230 | 40 | 30 |
| 230 – 1000 | 47 | 37 |

FREQUENCY RANGE OF RADIATED MEASUREMENT (For unintentional radiators)

| Highest frequency generated or Upper frequency of measurement used in the device or on which the device operates or tunes (MHz) | Range (MHz) |
|---|--|
| Below 108 | 1000 |
| 108 – 500 | 2000 |
| 500 – 1000 | 5000 |
| Above 1000 | Up to 5 times of the highest frequency or 6 GHz, whichever is less |

FOR FREQUENCY ABOVE 1000 MHz

| FREQUENCY (GHz) | Class A (dBuV/m) (at 3m) | | Class B (dBuV/m) (at 3m) | |
|-----------------|--------------------------|---------|--------------------------|---------|
| | PEAK | AVERAGE | PEAK | AVERAGE |
| 1 to 3 | 76 | 56 | 70 | 50 |
| 3 to 6 | 80 | 60 | 74 | 54 |

- NOTE: (1) The lower limit shall apply at the transition frequencies.
 (2) Emission level (dBuV/m) = 20 log Emission level (uV/m).
 (3) All emanation from a class A/B digital device or system, including any network of conductors and apparatus connected thereto, shall not exceed the level of field strengths specified above.

Bureau Veritas Shenzhen Co., Ltd.
Dongguan Branch

No. 34, Chenwulu Section, Guantai Rd., Houjie Town, Dongguan City, Guangdong 523942, China

Tel: +86 769 8593 5656
Fax: +86 769 8593 1080
Email: customerservice.dg@cn.bureauveritas.com

Page 18 of 66

Report Version 1

Bureau Veritas Shenzhen Co., Ltd.
Dongguan Branch

No. 34, Chenwulu Section, Guantai Rd., Houjie Town, Dongguan City, Guangdong 523942, China
Page 52 of 127

Tel: +86 769 8593 5656
Fax: +86 769 8599 1080
Email: customerservice.dg@cn.bureauveritas.com
TEST REPORT EN 50438 VER.1



3.2.2 TEST INSTRUMENTS

Frequency Range 30MHz-1GHz

| Equipment | Manufacturer | Model No. | Serial No. | Last Cal. | Next Cal. |
|---------------------------|---------------|--------------------------|------------|-------------|-------------|
| EMI Test Receiver | Rohde&Schwarz | ESCI | 100962 | Mar. 06,14 | Mar. 05,15 |
| Bilog Antenna | Teseq | CBL 6111D | 27089 | Jul. 27, 13 | Jul. 26, 14 |
| Trilog-Broadband Antenna | SCHWARZBECK | VULB 9168 | 9168-554 | Dec. 03, 13 | Dec. 02, 14 |
| Trilog-Broadband Antenna | SCHWARZBECK | VULB 9168 | 9168-555 | Dec. 03, 13 | Dec. 02, 14 |
| 10m Semi-anechoic Chamber | CHANGLING | 21.4m*12.1m*8.8m | NSEMC006 | Jun. 11, 13 | Jun. 10, 14 |
| Amplifier (9kHz-1GHz) | SONOMA | 310D | 186955 | Mar. 05,14 | Mar. 04, 15 |
| Test Software | ADT | ADT_Radiated_V7.6.15.9.2 | N/A | N/A | N/A |

Frequency Range Above1GHz

| Equipment | Manufacturer | Model No. | Serial No. | Last Cal. | Next Cal. |
|--------------------------------|---------------|--------------------------|------------|------------|-------------|
| Horn Antenna | ETS-Lindgren | 3117 | 00062558 | Oct. 18,12 | Oct. 17, 14 |
| EMI Test Receiver | Rohde&Schwarz | ESCI | 100962 | Mar. 06,14 | Mar. 05,15 |
| Spectrum Analyzer | Rohde&Schwarz | FSV40 | 101003 | Apr. 09,14 | Apr. 08,15 |
| Pre-Amplifier (100MHz-26.5GHz) | EMCI | EMC 012645 | 980077 | Nov. 07,13 | Nov. 06,14 |
| Pre-Amplifier (18GHz-40GHz) | EMCI | EMC 184045 | 980102 | Nov. 04,13 | Nov. 03,14 |
| Test Software | ADT | ADT_Radiated_V7.6.15.9.2 | N/A | N/A | N/A |

- NOTE: 1. The calibration interval of the above test instruments is 12 months. And the calibrations are traceable to CEPREI/CHINA and NIM/CHINA.
2. The test was performed in Chamber 10m.



3.2.3 TEST PROCEDURE

<Frequency Range below 1GHz>

- a. The EUT was placed on the top of a rotating table 0.8 meters above the ground at a 10 meter chamber room. The table was rotated 360 degrees to determine the position of the highest radiation.
- b. The EUT was set 10 meters away from the interference-receiving antenna, which was mounted on the top of a variable-height antenna tower.
- c. The height of antenna is varied from one meter to four meters above the ground to determine the maximum value of the field strength. Both horizontal and vertical polarizations of the antenna are set to make the measurement.
- d. For each suspected emission, the EUT was arranged to its worst case and then the antenna was tuned to heights from 1 meter to 4 meters and the turn table was turned from 0 degrees to 360 degrees to find the maximum reading.
- e. The test-receiver system was set to quasi-peak detect function and specified bandwidth with maximum hold mode when the test frequency is below 1 GHz.

NOTE:

1. The resolution bandwidth of test receiver/spectrum analyzer is 120kHz for Quasi-peak detection (QP) at frequency below 1GHz.
2. Emission level(dBuV/m)=Raw Value(dBuV) + Correction Factor(dB/m)
3. Correction Factor(dB/m) = Antenna Factor (dB/m) + Cable Factor (dB)
4. Margin value = Emission level – Limit value.



<Frequency Range above 1GHz>

- a. The EUT was placed on the top of a rotating table 0.8 meters above the ground at a 10 meter Semi-anechoic chamber room. The table was rotated 360 degrees to determine the position of the highest radiation.
- b. The EUT was set 3 meters away from the interference-receiving antenna, which was mounted on the top of a variable-height antenna tower.
- c. The height of antenna can be varied from one meter to four meters, the height of adjustment depends on the EUT height and the antenna 3dB beamwidth both, to detect the maximum value of the field strength. Both horizontal and vertical polarizations of the antenna are set to make the measurement.
- d. For each suspected emission, the EUT was arranged to its worst case and then the antenna was tuned to heights and the rotatable table was turned from 0 degrees to 360 degrees to find the maximum reading.
- e. The test receiver/spectrum was set to peak and average detect function and specified bandwidth with maximum hold mode when the test frequency is above 1 GHz.

NOTE:

1. The resolution bandwidth is 1MHz and video bandwidth of test receiver/spectrum analyzer is 3MHz for Peak detection at frequency above 1GHz. The resolution bandwidth of test receiver/spectrum analyzer is 1 MHz for Average detection (AV) at frequency above 1GHz.
2. For measurement of frequency above 1000 MHz, the EUT was set 3 meters away from the receiver antenna.

3.2.4 DEVIATION FROM TEST STANDARD

No deviation



BUREAU
VERITAS Test Report No.: CE140508N005R1

3.2.5 TEST SETUP

<Frequency Range below 1GHz>

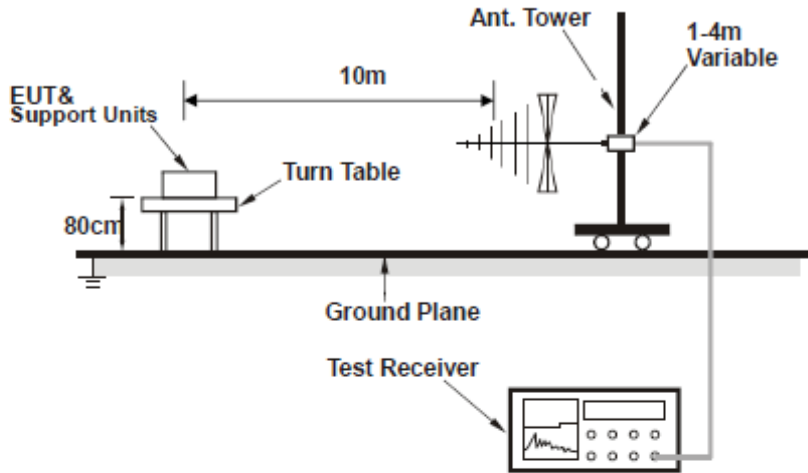

<Frequency Range above 1GHz>

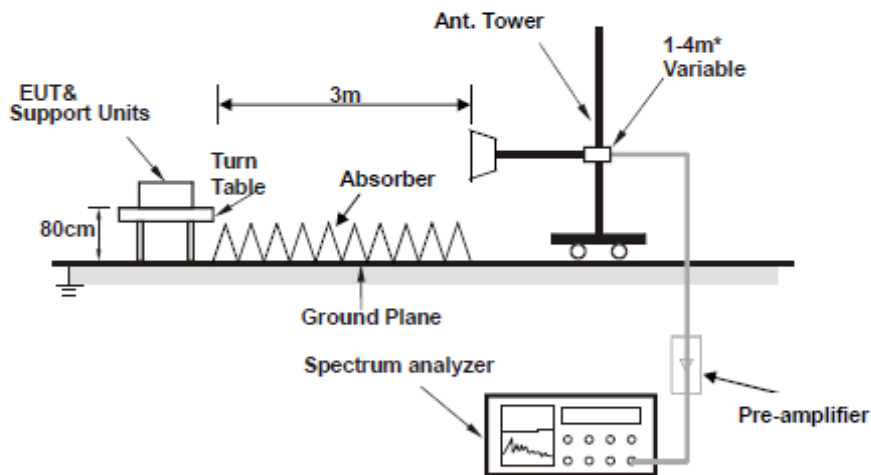

* : depends on the EUT height and the antenna 3dB beamwidth both, refer to section 7.3 of CISPR 16-2-3.

3.2.6 EUT OPERATING CONDITIONS

Same as item 3.1.6

Bureau Veritas Shenzhen Co., Ltd.
Dongguan Branch

No. 34, Chenwulu Section, Guantai Rd., Houjie
Town, Dongguan City,
Guangdong 523942, China

Tel: +86 769 8593 5656
Fax: +86 769 8593 1080
Email: customerservice.dg@cn.bureauveritas.com

Page 22 of 66

Report Version 1



BUREAU VERITAS Test Report No.: CE140508N005R1

3.2.7 TEST RESULTS

| | | | |
|--------------------------|---------------------------|-------------------------------|--------------------|
| TEST MODE | SOFAR 3000TL Grid Mode | FREQUENCY RANGE | 30-1000 MHz |
| TEST VOLTAGE | DC 360V | DETECTOR FUNCTION & BANDWIDTH | Quasi-Peak, 120kHz |
| ENVIRONMENTAL CONDITIONS | 25 deg. C, 50% RH | TESTED BY: Robert | |

| ANTENNA POLARITY & TEST DISTANCE: HORIZONTAL AT 10 M | | | | | | | | |
|--|-------------|--------------------------|------------------|-------------------------|----------------|-------------|---------------------|----------------------|
| No. | Freq. (MHz) | Correction Factor (dB/m) | Raw Value (dBuV) | Emission Level (dBuV/m) | Limit (dBuV/m) | Margin (dB) | Antenna Height (cm) | Table Angle (Degree) |
| 1 | 43.58 | 14.96 | -0.74 | 14.22 | 30.00 | -15.78 | 143 | 12 |
| 2 | 92.08 | 10.26 | 9.47 | 19.73 | 30.00 | -10.27 | 400 | 31 |
| 3 | 113.42 | 12.35 | 9.75 | 22.10 | 30.00 | -7.90 | 400 | 313 |
| 4 | 130.88 | 13.26 | 11.50 | 24.76 | 30.00 | -5.24 | 400 | 122 |
| 5 | 183.26 | 12.88 | 6.59 | 19.47 | 30.00 | -10.53 | 219 | 132 |
| 6 | 247.28 | 14.09 | 5.71 | 19.80 | 37.00 | -17.20 | 100 | 13 |

REMARKS: The emission levels of other frequencies were very low against the limit..

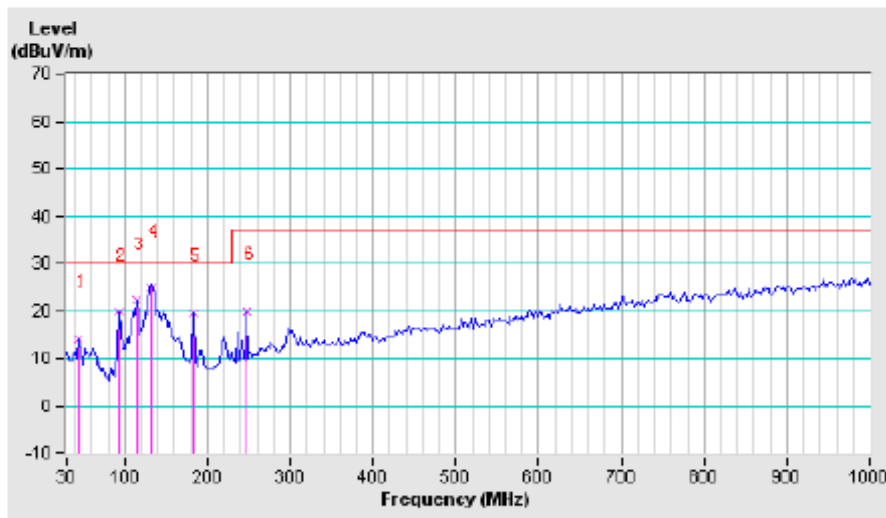

Bureau Veritas Shenzhen Co., Ltd.
Dongguan Branch

No. 34, Chenwulu Section, Guantai Rd., Houjie
Town, Dongguan City,
Guangdong 523942, China

Tel: +86 769 8593 5656
Fax: +86 769 8593 1080
Email: customerservice.dg@cn.bureauveritas.com

Page 23 of 66

Report Version 1

Bureau Veritas Shenzhen Co., Ltd.
Dongguan Branch

No. 34, Chenwulu Section, Guantai Rd.,
Houjie Town, Dongguan City, Guangdong
523942, China
Page 57 of 127

Tel: +86 769 8593 5656
Fax: +86 769 8599 1080
Email: customerservice.dg@cn.bureauveritas.com
TEST REPORT EN 50438 VER.1



| | | | |
|--------------------------|---------------------------|-------------------------------|--------------------|
| TEST MODE | SOFAR 3000TL Grid Mode | FREQUENCY RANGE | 30-1000 MHz |
| TEST VOLTAGE | DC 360V | DETECTOR FUNCTION & BANDWIDTH | Quasi-Peak, 120kHz |
| ENVIRONMENTAL CONDITIONS | 25 deg. C, 50% RH | TESTED BY: Robert | |

| ANTENNA POLARITY & TEST DISTANCE: VERTICAL AT 10 M | | | | | | | | |
|--|-------------|--------------------------|------------------|-------------------------|----------------|-------------|---------------------|----------------------|
| No. | Freq. (MHz) | Correction Factor (dB/m) | Raw Value (dBuV) | Emission Level (dBuV/m) | Limit (dBuV/m) | Margin (dB) | Antenna Height (cm) | Table Angle (Degree) |
| 1 | 43.58 | 14.96 | 9.04 | 24.00 | 30.00 | -6.00 | 195 | 129 |
| 2 | 61.04 | 13.28 | 9.31 | 22.59 | 30.00 | -7.41 | 165 | 104 |
| 3 | 94.00 | 10.50 | 12.90 | 23.40 | 30.00 | -6.60 | 100 | 20 |
| 4 | 130.88 | 13.26 | 6.84 | 20.10 | 30.00 | -9.90 | 100 | 20 |
| 5 | 191.02 | 12.37 | 12.55 | 24.92 | 30.00 | -5.08 | 128 | 72 |
| 6 | 220.12 | 12.64 | 8.38 | 21.02 | 30.00 | -8.98 | 231 | 160 |

REMARKS: The emission levels of other frequencies were very low against the limit.

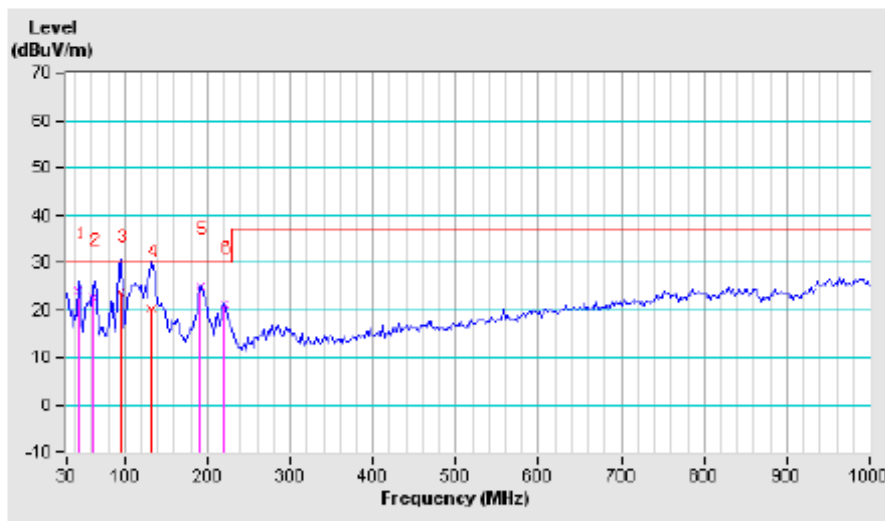



3.3 HARMONICS CURRENT MEASUREMENT (<16A)

3.3.1 LIMITS OF HARMONICS CURRENT MEASUREMENT

TEST STANDARD: EN 61000-3-2

| Limits for Class A equipment | | Limits for Class D equipment | | |
|------------------------------|--------------------------------------|------------------------------|--|--------------------------------------|
| Harmonic Order n | Max. permissible harmonics current A | Harmonic Order n | Max. permissible harmonics current per watt mA/W | Max. permissible harmonics current A |
| Odd harmonics | | Odd Harmonics only | | |
| 3 | 2.30 | 3 | 3.4 | 2.30 |
| 5 | 1.14 | 5 | 1.9 | 1.14 |
| 7 | 0.77 | 7 | 1.0 | 0.77 |
| 9 | 0.40 | 9 | 0.5 | 0.40 |
| 11 | 0.33 | 11 | 0.35 | 0.33 |
| 13 | 0.21 | 13 | 0.30 | 0.21 |
| 15<=n<=39 | 0.15x15/n | 15<=n<=39 | 3.85/n | 0.15x15/n |
| Even harmonics | | | | |
| 2 | 1.08 | | | |
| 4 | 0.43 | | | |
| 6 | 0.30 | | | |
| 8<=n<=40 | 0.23x8/n | | | |

NOTE: 1. Class A and Class D are classified according to section 5 of EN 61000-3-2.

2. According to section 7 of EN 61000-3-2, the above limits for all equipment except for lighting equipment having an active power input > 75 W and no limits apply for equipment with an active power input up to and including 75 W.

◆ **Limits for Class B equipment:**

For class B equipment, the harmonics of the input current shall not exceed the maximum permissible values given for class A equipment multiplied by a factor of 1.5.

| Limits for Class C equipment | |
|---------------------------------------|--|
| Harmonic Order n | Max. permissible harmonics current expressed as a percentage of the input current at the fundamental frequency % |
| 2 | 2 |
| 3 | $30 \cdot \lambda$ |
| 5 | 10 |
| 7 | 7 |
| 9 | 5 |
| 11<=n<=39 (odd harmonics only) | 3 |
| λ is the circuit power factor | |

NOTE: Discharge lighting equipment having an active TEST VOLTAGE smaller than or equal to 25W, the harmonic currents shall not exceed the power related limits of Class D.



3.3.2 TEST INSTRUMENTS

| DESCRIPTION & MANUFACTURER | MANUFACTURER | MODEL NO. | SERIAL NO. | CALIBRATED DATE | CALIBRATED UNTIL |
|-----------------------------|--------------|-----------|------------|-----------------|------------------|
| PRECISION POWER ANALYZER | YOKOGAWA | WT3000 | 91M210852 | Mar. 12,14 | Mar. 11,15 |
| Test Software | YOKOGAWA | IEC61000 | N/A | N/A | N/A |
| REFERENCE IMPEDANCE NETWORK | Voltech | EUR | 3018 | N/A | N/A |

NOTE: 1. The test was performed in PV Room.

2. The calibration interval of the above test instruments is 12 months and the calibrations are traceable to CEPREI/CHINA, GRGT/CHINA and NIM/CHINA.

3.3.3 TEST PROCEDURE

- a. The EUT was placed on the top of a wooden table 0.8 meters above the ground and operated to produce the maximum harmonic components under normal operating conditions for each successive harmonic component in turn.
- b. The classification of EUT is according to section 5 of EN 61000-3-2:2006 + A1:2009 + A2:2009.

The EUT is classified as follows:

Class A: Balanced three-phase equipment, Household appliances excluding equipment as Class D, Tools excluding portable tools, Dimmers for incandescent lamps, audio equipment, equipment not specified in one of the three other classes.

Class B: Portable tools. ; Arc welding equipment which is not professional equipment

Class C: Lighting equipment.

Class D: Equipment having a specified power less than or equal to 600 W of the following types: Personal computers and personal computer monitors and television receivers.

- c. The correspondent test program of test instrument to measure the current harmonics emanated from EUT is chosen. The measure time shall be not less than the time necessary for the EUT to be exercised.



3.3.4 DEVIATION FROM TEST STANDARD

No deviation

3.3.5 TEST SETUP

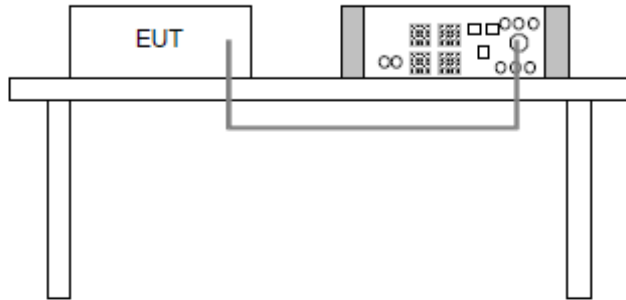

3.3.6 EUT OPERATING CONDITIONS

Same as item 3.1.6



BUREAU VERITAS

Test Report No.: CE140508N005R1

3.3.7 TEST RESULTS

SOFAR 1100TL

***** appliances (Average)

Print Date : Mon May 26 14:15:38 2014
 MeasureDate : Mon May 26 14:15:34 2014
 Comment : Experimental model Pattern A

Regulation : IEC61000-3-2 Ed3.0 am2
 IEC61000-4-7 Ed2.0 A1
 Class : CLASS A
 MeasureTime : 150.00sec
 Model : YOKOGAWA WT3000
 Rating Voltage : 230.00 V
 Wiring : single-phase 2-wire
 Element : 1
 Range : 300V/30A
 Current(rms) : 4.2800 A
 Voltage(rms) : 230.42 V
 Frequency : 50.000 Hz
 Power Factor : 0.9957
 POHC Limit : 0.2514 A
 POHC Max : 0.0040 A
 THC : 0.0958 A

PASS

Set Fundamental I : -----
 Set Power Factor : -----
 Set P : -----
 Sigma W Max : 982.9105 W
 Sigma PF : 0.9957
 Distortion factor(V) : 0.05 %
 V THDS : 0.05 %
 V THDG : 0.05 %
 Distortion factor(A) : 1.53 %
 A THDS : 1.53 %
 A THDG : 1.64 %
 P THD : 0.00 %
 Power Limit : 75 W

| Order | Measure[A] | Limit[A] | Margin[%] | Order | Measure[A] | Limit[A] | Margin[%] |
|-------|------------|----------|-----------|-------|------------|----------|-----------|
| 1 | 4.2796 | | | 2 | 0.0036 | 1.0000 | 99.1 |
| 3 | 0.0832 | 2.3000 | 97.3 | 4 | 0.0045 | 0.4300 | 99.0 |
| 5 | 0.0596 | 1.1400 | 99.2 | 6 | 0.0031 | 0.3000 | 99.0 |
| 7 | 0.0464 | 0.7700 | 99.2 | 8 | 0.0022 | 0.2300 | 99.0 |
| 9 | 0.0338 | 0.4000 | 99.1 | 10 | 0.0023 | 0.1840 | 99.8 |
| 11 | 0.0023 | 0.3300 | 99.4 | 12 | 0.0023 | 0.1533 | 99.5 |
| 13 | 0.0018 | 0.2100 | 99.1 | 14 | 0.0018 | 0.1314 | 99.6 |
| 15 | 0.0018 | 0.1500 | 99.0 | 16 | 0.0018 | 0.1150 | 99.6 |
| 17 | 0.0014 | 0.1324 | 99.0 | 18 | 0.0018 | 0.1022 | 99.3 |
| 19 | 0.0015 | 0.1184 | 99.8 | 20 | 0.0018 | 0.0920 | 99.3 |
| 21 | 0.0017 | 0.1071 | 99.4 | 22 | 0.0013 | 0.0836 | 99.4 |
| 23 | 0.0014 | 0.0978 | 99.6 | 24 | 0.0012 | 0.0767 | 99.4 |
| 25 | 0.0015 | 0.0900 | 99.3 | 26 | 0.0014 | 0.0708 | 99.0 |
| 27 | 0.0012 | 0.0833 | 99.6 | 28 | 0.0011 | 0.0657 | 99.3 |
| 29 | 0.0012 | 0.0776 | 99.5 | 30 | 0.0010 | 0.0513 | 99.4 |
| 31 | 0.0016 | 0.0728 | 99.7 | 32 | 0.0011 | 0.0575 | 99.1 |
| 33 | 0.0011 | 0.0682 | 99.4 | 34 | 0.0013 | 0.0541 | 97.6 |
| 35 | 0.0011 | 0.0543 | 99.3 | 36 | 0.0012 | 0.0511 | 97.7 |
| 37 | 0.0008 | 0.0508 | 99.5 | 38 | 0.0012 | 0.0484 | 97.8 |
| 39 | 0.0008 | 0.0577 | 99.5 | 40 | 0.0015 | 0.0460 | 96.9 |

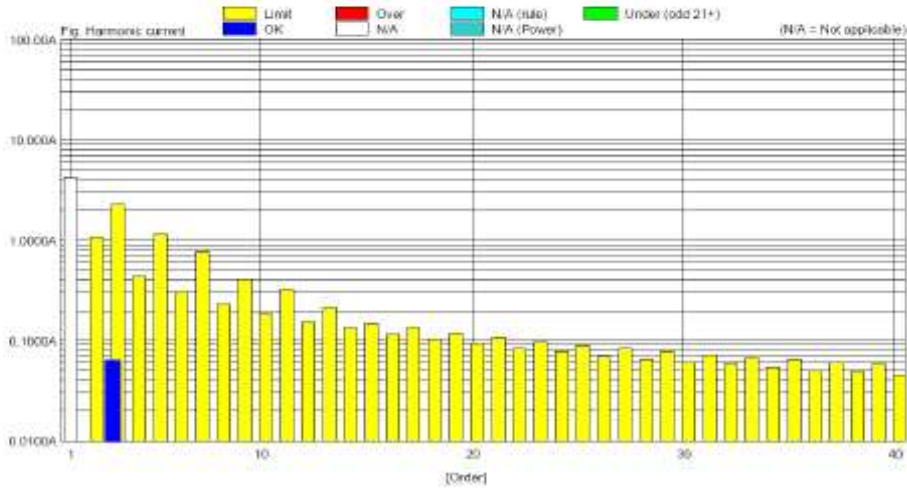

Bureau Veritas Shenzhen Co., Ltd.
 Dongguan Branch

No. 34, Chenwulu Section, Guantai Rd., Houjie
 Town, Dongguan City,
 Guangdong 523942, China

Tel: +86 769 8593 5656
 Fax: +86 769 8593 1080
 Email: customerservice.dg@cn.bureauveritas.com



Test Report No.: CE140508N005R1

***** appliances (Maximum)

Print Date : Mon May 26 14:15:38 2014
 MeasureDate : Mon May 26 14:15:34 2014
 Comment : Experimental model Pattern A

Regulation : IEC61008-3-2 Ed3.0 am2
 IEC61008-4-7 Ed2.0 A1
 Class : CLASS A
 MeasureTime : 150.00sec
 Model : YOKOGAWA WT3000
 Rating Voltage : 230.00 V
 Wiring : single-phase 2-wire
 Element :
 Range : 300V/30A
 Current(rms) : 4.2840 A
 Voltage(rms) : 230.42 V
 Frequency : 50.004 Hz
 Power Factor : 0.9957
 Beyond Limit Time : 15.0000 s
 Beyond Total Time : 0.0000 s
 THC : 0.0661 A

PASS

Set Fundamental I : -----
 Set Power Factor : -----
 Set P : -----
 Sigma W Max : 982.9105 W
 Sigma PF : 0.9957
 Distortion factor(V) : 0.05 %
 V THDS : 0.05 %
 V THDG : 0.05 %
 Distortion factor(A) : 1.55 %
 A THDS : 1.55 %
 A THDG : 1.56 %
 P THD : 0.00 %
 Power Limit : 75 W

| Order | Measure[A] | Limit[A] | Margin[%] | Order | Measure[A] | Limit[A] | Margin[%] |
|-------|------------|----------|-----------|-------|------------|----------|-----------|
| 1 | 4.2835 | | | 2 | 0.0100 | 1.6200 | 99.4 |
| 3 | 0.0635 | 3.4500 | 98.2 | 4 | 0.0047 | 0.8450 | 99.3 |
| 5 | 0.0589 | 1.7100 | 99.4 | 6 | 0.0033 | 0.4500 | 99.3 |
| 7 | 0.0550 | 1.1550 | 99.5 | 8 | 0.0024 | 0.3450 | 99.3 |
| 9 | 0.0325 | 0.6000 | 99.4 | 10 | 0.0025 | 0.2760 | 99.1 |
| 11 | 0.0322 | 0.4950 | 99.5 | 12 | 0.0025 | 0.2300 | 98.9 |
| 13 | 0.0321 | 0.3150 | 99.3 | 14 | 0.0022 | 0.1871 | 99.0 |
| 15 | 0.0315 | 0.2250 | 99.3 | 16 | 0.0019 | 0.1725 | 99.0 |
| 17 | 0.0315 | 0.1985 | 99.2 | 18 | 0.0019 | 0.1533 | 98.8 |
| 19 | 0.0316 | 0.1776 | 99.1 | 20 | 0.0017 | 0.1380 | 98.7 |
| 21 | 0.0319 | 0.1507 | 98.8 | 22 | 0.0015 | 0.1255 | 98.8 |
| 23 | 0.0316 | 0.1457 | 98.9 | 24 | 0.0015 | 0.1150 | 98.8 |
| 25 | 0.0316 | 0.1350 | 98.8 | 26 | 0.0015 | 0.1062 | 98.8 |
| 27 | 0.0313 | 0.1250 | 98.9 | 28 | 0.0012 | 0.0985 | 98.8 |
| 29 | 0.0313 | 0.1184 | 98.9 | 30 | 0.0010 | 0.0920 | 98.9 |
| 31 | 0.0311 | 0.1089 | 99.0 | 32 | 0.0012 | 0.0662 | 98.9 |
| 33 | 0.0313 | 0.1023 | 98.8 | 34 | 0.0014 | 0.0812 | 98.3 |
| 35 | 0.0312 | 0.0964 | 98.7 | 36 | 0.0013 | 0.0767 | 98.4 |
| 37 | 0.0310 | 0.0912 | 98.9 | 38 | 0.0013 | 0.0725 | 98.3 |
| 39 | 0.0310 | 0.0865 | 98.9 | 40 | 0.0018 | 0.0690 | 97.7 |

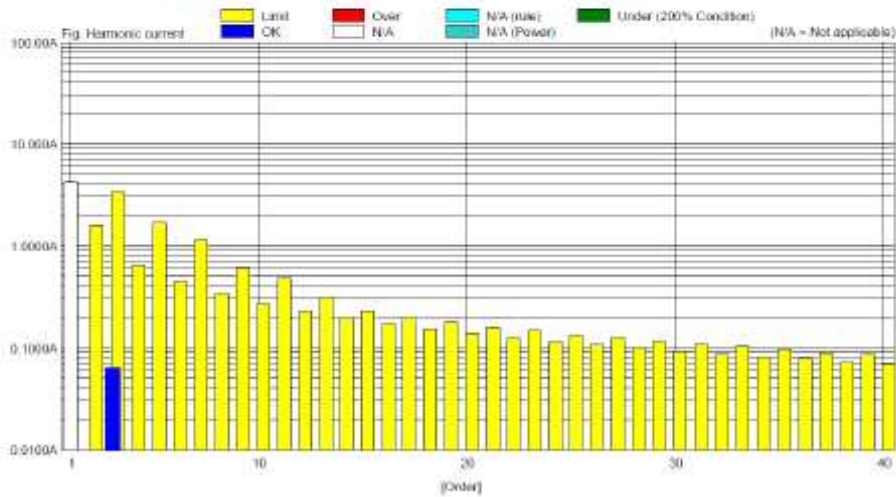

Bureau Veritas Shenzhen Co., Ltd.
 Dongguan Branch

No. 34, Chenwulu Section, Guantai Rd., Houjie
 Town, Dongguan City,
 Guangdong 523942, China

Tel: +86 769 8593 5656
 Fax: +86 769 8593 1080
 Email: customerservice.dg@cn.bureauveritas.com



Test Report No.: CE140508N005R1
SOFAR 3000TL

******* appliances (Average)**

Print Date : Wed Jun 11 11:32:38 2014
 Measure Date : Wed Jun 11 11:31:38 2014
 Comment : Experimental model Pattern A

Regulation : IEC81000-3-2 E43 0 am2
 IEC81000-4-7 E42 0 A1
 Class : CLASS A
 Measure Time : 150.00sec
 Model : YOKOGAWA WT3000
 Rating Voltage : 230.00 V
 Wiring : single-phase 2-wire
 Element : 2
 Range : 300V/30A
 Current(rms) : 12.1893 A
 Voltage(rms) : 229.89 V
 Frequency : 49.999 Hz
 Power Factor : 0.9988
 PDHC Limit : 0.2514 A
 PDHC Max : 0.0365 A
 THC : 0.1683 A

PASS

Set Fundamental I : -----
 Set Power Factor : -----
 Set P : -----
 Sigma VV Max : 2804.014 W
 Sigma PF : 0.9988
 Distortion factor(V) : 0.04 %
 V THDS : 0.04 %
 V THDG : 0.04 %
 Distortion factor(A) : 1.38 %
 A THDS : 1.38 %
 A THDG : 1.38 %
 P THD : 0.00 %
 Power Limit : 75 W

| Order | Measure[A] | Limit[A] | Margin[%] | Order | Measure[A] | Limit[A] | Margin[%] |
|-------|------------|----------|-----------|-------|------------|----------|-----------|
| 1 | 12.1893 | | | 2 | 0.0091 | 1.0800 | 99.2 |
| 3 | 0.1680 | 2.3000 | 93.1 | 4 | 0.0062 | 0.4300 | 98.6 |
| 5 | 0.0310 | 1.1400 | 97.2 | 6 | 0.0031 | 0.3000 | 99.0 |
| 7 | 0.0138 | 0.7700 | 98.2 | 8 | 0.0031 | 0.2300 | 98.7 |
| 9 | 0.0054 | 0.4000 | 98.6 | 10 | 0.0040 | 0.1840 | 97.7 |
| 11 | 0.0009 | 0.3300 | 98.2 | 12 | 0.0037 | 0.1533 | 97.6 |
| 13 | 0.0121 | 0.2100 | 94.3 | 14 | 0.0040 | 0.1314 | 96.9 |
| 15 | 0.0102 | 0.1500 | 83.2 | 16 | 0.0032 | 0.1150 | 97.3 |
| 17 | 0.0129 | 0.1324 | 90.3 | 18 | 0.0034 | 0.1022 | 97.7 |
| 19 | 0.0130 | 0.1184 | 88.3 | 20 | 0.0035 | 0.0920 | 97.2 |
| 21 | 0.0148 | 0.1071 | 86.3 | 22 | 0.0019 | 0.0838 | 97.8 |
| 23 | 0.0137 | 0.0878 | 88.0 | 24 | 0.0018 | 0.0767 | 97.9 |
| 25 | 0.0133 | 0.0800 | 85.2 | 26 | 0.0015 | 0.0708 | 97.3 |
| 27 | 0.0130 | 0.0633 | 84.4 | 28 | 0.0017 | 0.0657 | 97.3 |
| 29 | 0.0119 | 0.0776 | 84.7 | 30 | 0.0013 | 0.0613 | 97.8 |
| 31 | 0.0107 | 0.0726 | 85.3 | 32 | 0.0012 | 0.0575 | 98.0 |
| 33 | 0.0094 | 0.0652 | 86.1 | 34 | 0.0012 | 0.0541 | 97.7 |
| 35 | 0.0091 | 0.0643 | 85.9 | 36 | 0.0011 | 0.0511 | 97.8 |
| 37 | 0.0079 | 0.0608 | 87.1 | 38 | 0.0013 | 0.0484 | 97.2 |
| 39 | 0.0077 | 0.0577 | 86.6 | 40 | 0.0012 | 0.0480 | 97.4 |

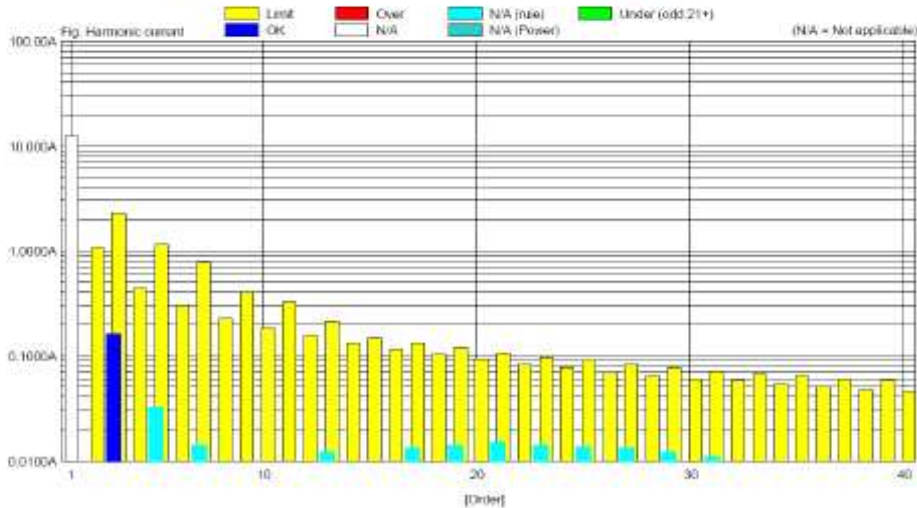

Bureau Veritas Shenzhen Co., Ltd.
 Dongguan Branch

No. 34, Chenwulu Section, Guantai Rd., Houjie
 Town, Dongguan City,
 Guangdong 523942, China

Tel: +86 769 8593 5656
 Fax: +86 769 8593 1080
 Email: customerservice.dg@cn.bureauveritas.com

***** appliances (Maximum)

Print Date : Wed Jun 11 11:32:39 2014
 MeasureDate : Wed Jun 11 11:31:38 2014
 Comment : Experimental model Pattern A

Regulation : IEC61000-3-2 Ed3.0 am2
 IEC61000-4-7 Ed2.0 A1
 Class : CLASS A
 MeasureTime : 150.00sec
 Model : YOKOGAWA WT3000
 Rating Voltage : 230.00 V
 Wiring : single-phase 2-wire
 Element : 2
 Range : 300V/30A
 Current(rms) : 12.1941 A
 Voltage(rms) : 229.89 V
 Frequency : 50.018 Hz
 Power Factor : 0.9988
 Beyond Limit Time : 15.0002 s
 Beyond Total Time : 0.0000 s
 THC : 0.1694 A

PASS

Set Fundamental I : -----
 Set Power Factor : -----
 Set P : -----
 Sigma W Max : 2904.014 W
 Sigma PF : 0.9988
 Distortion factor(V) : 0.04 %
 V THDS : 0.04 %
 V THDG : 0.04 %
 Distortion factor(A) : 1.40 %
 A THDS : 1.40 %
 A THDG : 1.40 %
 P THD : 0.00 %
 Power Limit : 75 W

| Order | Measure[A] | Limit[A] | Margin[%] | Order | Measure[A] | Limit[A] | Margin[%] |
|-------|------------|----------|-----------|-------|------------|----------|-----------|
| 1 | 12.1929 | | | 2 | 0.0067 | 1.6200 | 99.5 |
| 3 | 0.1691 | 3.4500 | 95.4 | 4 | 0.0067 | 0.6450 | 99.0 |
| 5 | 0.0322 | 1.7100 | 98.1 | 5 | 0.0033 | 0.4500 | 99.2 |
| 7 | 0.0146 | 1.1550 | 98.7 | 8 | 0.0054 | 0.3450 | 99.0 |
| 9 | 0.0068 | 0.8000 | 99.0 | 10 | 0.0041 | 0.2760 | 99.3 |
| 11 | 0.0050 | 0.4950 | 96.7 | 12 | 0.0040 | 0.2300 | 99.2 |
| 13 | 0.0129 | 0.3150 | 95.9 | 14 | 0.0061 | 0.1971 | 97.4 |
| 15 | 0.0199 | 0.2250 | 95.2 | 16 | 0.0035 | 0.1725 | 99.0 |
| 17 | 0.0194 | 0.1985 | 93.3 | 18 | 0.0027 | 0.1533 | 99.2 |
| 19 | 0.0142 | 0.1778 | 92.0 | 20 | 0.0028 | 0.1380 | 97.9 |
| 21 | 0.0190 | 0.1807 | 90.7 | 22 | 0.0021 | 0.1256 | 99.4 |
| 23 | 0.0139 | 0.1467 | 90.5 | 24 | 0.0019 | 0.1150 | 99.4 |
| 25 | 0.0130 | 0.1350 | 89.9 | 26 | 0.0022 | 0.1062 | 99.0 |
| 27 | 0.0132 | 0.1250 | 89.4 | 28 | 0.0020 | 0.0988 | 99.0 |
| 29 | 0.0121 | 0.1164 | 89.6 | 30 | 0.0019 | 0.0920 | 99.4 |
| 31 | 0.0108 | 0.1089 | 90.0 | 32 | 0.0013 | 0.0862 | 99.5 |
| 33 | 0.0097 | 0.1023 | 90.6 | 34 | 0.0014 | 0.0812 | 99.3 |
| 35 | 0.0092 | 0.0964 | 90.4 | 36 | 0.0012 | 0.0767 | 99.4 |
| 37 | 0.0081 | 0.0912 | 91.1 | 38 | 0.0016 | 0.0726 | 97.9 |
| 39 | 0.0076 | 0.0865 | 90.8 | 40 | 0.0014 | 0.0680 | 97.9 |

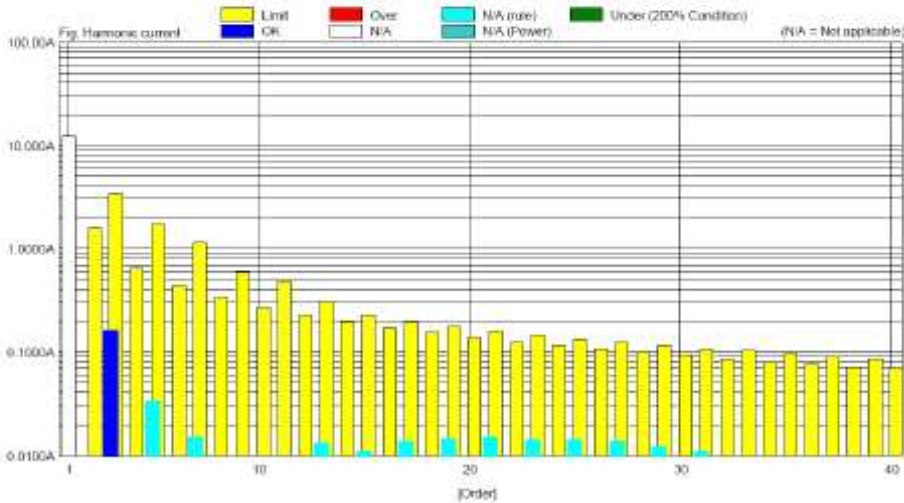

Bureau Veritas Shenzhen Co., Ltd.
 Dongguan Branch

No. 34, Chenwulu Section, Guantai Rd., Houjie
 Town, Dongguan City,
 Guangdong 523942, China

Tel: +86 769 8593 5656
 Fax: +86 769 8593 1080
 Email: customerservice.dg@cn.bureauveritas.com



BUREAU VERITAS Test Report No.: CE140508N005R1

3.4 VOLTAGE FLUCTUATION AND FLICKS MEASUREMENT

3.4.1 LIMITS OF VOLTAGE FLUCTUATION AND FLICKS MEASUREMENT

TEST STANDARD: EN 61000-3-3

| TEST ITEM | LIMIT | NOTE |
|-----------------|-------|---|
| P_{st} | 1.0 | P_{st} means short-term flicker indicator. |
| P_{lt} | 0.65 | P_{lt} means long-term flicker indicator. |
| $T_{d(t)}$ (ms) | 500 | $T_{d(t)}$ means maximum time that $d(t)$ exceeds 3.3%. |
| d_{max} (%) | 4 | d_{max} means maximum relative voltage change. |
| dc (%) | 3.3 | dc means relative steady-state voltage change |

3.4.2 TEST INSTRUMENTS

| DESCRIPTION & MANUFACTURER | MANUFACTURER | MODEL NO. | SERIAL NO. | CALIBRATED DATE | CALIBRATED UNTIL |
|-----------------------------|--------------|-----------|------------|-----------------|------------------|
| PRECISION POWER ANALYZER | YOKOGAWA | WT3000 | 91M210852 | Mar. 12,14 | Mar. 11,15 |
| Test Software | YOKOGAWA | IEC61000 | N/A | N/A | N/A |
| REFERENCE IMPEDANCE NETWORK | Voltech | EUR | 3018 | N/A | N/A |

NOTE: 1. The test was performed in PV Room.

2. The calibration interval of the above test instruments is 12 months and the calibrations are traceable to CEPREI/CHINA, GRGT/CHINA and NIM/CHINA.

3.4.3 TEST PROCEDURE

- a. The EUT was placed on the top of a wooden table 0.8 meters above the ground and operated to produce the most unfavorable sequence of voltage changes under Normal Operating conditions.
- b. During the flick measurement, the measure time shall include that part of whole operation cycle in which the EUT produce the most unfavorable sequence of voltage changes. The observation period for short-term flicker indicator is 120 minutes

Bureau Veritas Shenzhen Co., Ltd.
Dongguan Branch

No. 34, Chenwulu Section, Guantai Rd., Houjie
Town, Dongguan City,
Guangdong 523942, China

Tel: +86 769 8593 5656
Fax: +86 769 8593 1080
Email: customerservice.dg@cn.bureauveritas.com

Page 32 of 66

Report Version 1

Bureau Veritas Shenzhen Co., Ltd.
Dongguan Branch

No. 34, Chenwulu Section, Guantai Rd.,
Houjie Town, Dongguan City, Guangdong
523942, China

Tel: +86 769 8593 5656
Fax: +86 769 8599 1080
Email: customerservice.dg@cn.bureauveritas.com

Page 66 of 127

TEST REPORT EN 50438 VER.1



3.4.4 DEVIATION FROM TEST STANDARD

No deviation

3.4.5 TEST SETUP

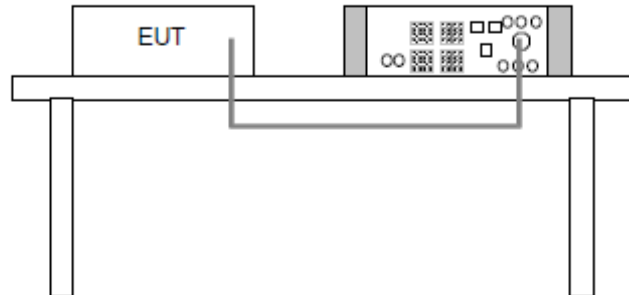

3.4.6 EUT OPERATING CONDITIONS

Same as item 3.1.6.



BUREAU
VERITAS

Test Report No.: CE140508N005R1

3.4.7 TEST RESULTS

SOFAR 1100TL

PV Inverter

Print Date : Mon May 26 16:26:18 2014
 MeasureDate : Mon May 26 16:25:54 2014
 Comment : Experimental model Pattern A

Regulation : IEC61000-3-3 Ed2.0
 IEC61000-4-15 Ed1.1
 Interval : 10Min0Sec
 Model : YOKOGAWA WT3000
 Wiring : single-phase 2-wire
 Voltage Range : 300.00V
 Voltage U1 : 231.81V
 Set Frequency : 50Hz
 Frequency U1 : 50.000Hz
 Element : 1
 dmin : 0.10%

PASS(Under dmin)

Element1 : Pass(Under dmin)
 dc (3.30%) : Pass
 dmax (4.00%) : Pass
 d(t) (500ms) : Pass
 Pst (1.00) : Pass
 PIt (0.65) : Pass

| No. | dc[%] | dmax[%] | d(t)[ms] | Pst |
|-----|-------|---------|----------|------|
| 1 | 0.00 | 0.00 | 0.00 | 0.07 |
| 2 | 0.00 | 0.00 | 0.00 | 0.07 |
| 3 | 0.00 | 0.00 | 0.00 | 0.07 |
| 4 | 0.00 | 0.00 | 0.00 | 0.07 |
| 5 | 0.00 | 0.00 | 0.00 | 0.07 |
| 6 | 0.00 | 0.00 | 0.00 | 0.07 |
| 7 | 0.00 | 0.00 | 0.00 | 0.07 |
| 8 | 0.00 | 0.00 | 0.00 | 0.07 |
| 9 | 0.00 | 0.00 | 0.00 | 0.07 |
| 10 | 0.00 | 0.00 | 0.00 | 0.07 |
| 11 | 0.00 | 0.00 | 0.00 | 0.07 |
| 12 | 0.00 | 0.00 | 0.00 | 0.07 |
| | | | PIt | 0.07 |

Bureau Veritas Shenzhen Co., Ltd.
 Dongguan Branch

No. 34, Chenwulu Section, Guantai Rd., Houjie
 Town, Dongguan City,
 Guangdong 523942, China

Tel: +86 769 8593 5656
 Fax: +86 769 8593 1080
 Email: customerservice_dg@cn.bureauveritas.com



PV Inverter

Print Date : Fri Jun 13 11:17:38 2014
 Measure Date : Fri Jun 13 11:17:28 2014
 Comment : Experimental model Pattern A

Regulation : IEC61000-3-3 Ed2.0
 IEC61000-4-15 Ed1.1
 Interval : 10Min0Sec
 Model : YOKOGAWA WT3000
 Wiring : single-phase 2-wire
 Voltage Range : 300.00V
 Voltage U1 : 234.15V
 Set Frequency : 50Hz
 Frequency U1 : 50.000Hz
 Element : 1
 dmin : 0.10%

PASS(Under dmin)

Element1 : Pass(Under dmin)
 dc (3.30%) : Pass
 dmax (4.00%) : Pass
 d(t) (500ms) : Pass
 Pst (1.00) : Pass
 PIt (0.66) : Pass

| No. | dc[%] | dmax[%] | d(t)[ms] | Pst |
|-----|-------|---------|----------|------|
| 1 | 0.00 | 0.00 | 0.00 | 0.07 |
| 2 | 0.00 | 0.00 | 0.00 | 0.07 |
| 3 | 0.00 | 0.00 | 0.00 | 0.07 |
| 4 | 0.00 | 0.00 | 0.00 | 0.07 |
| 5 | 0.00 | 0.00 | 0.00 | 0.07 |
| 6 | 0.00 | 0.00 | 0.00 | 0.07 |
| 7 | 0.00 | 0.00 | 0.00 | 0.07 |
| 8 | 0.00 | 0.00 | 0.00 | 0.07 |
| 9 | 0.00 | 0.00 | 0.00 | 0.07 |
| 10 | 0.00 | 0.00 | 0.00 | 0.07 |
| 11 | 0.00 | 0.00 | 0.00 | 0.07 |
| 12 | 0.00 | 0.00 | 0.00 | 0.07 |

Pst
0.07



4.1.2 PERFORMANCE CRITERIA

According to Clause 4 of EN 61000-6-2:2005 standard, the following describes the general performance criteria.

| | |
|-------------|--|
| CRITERION A | The apparatus shall continue to operate as intended during and after the test. No degradation of performance or loss of function is allowed below a performance level specified by the manufacturer, when the apparatus is used as intended. The performance level may be replaced by a permissible loss of performance. If the minimum performance level or the permissible performance loss is not specified by the manufacturer, either of these may be derived from the product description and documentation and what the user may reasonably expect from the apparatus if used as intended. |
| CRITERION B | The apparatus shall continue to operate as intended after the test. No degradation of performance or loss of function is allowed below a performance level specified by the manufacturer, when the apparatus is used as intended. The performance level may be replaced by a permissible loss of performance. During the test, degradation of performance is however allowed. No change of operating state or stored data is allowed. If the minimum performance level or the permissible performance loss is not specified by the manufacturer, either of these may be derived from the product description and documentation and what the user may reasonably expect from the apparatus if used as intended. |
| CRITERION C | Temporary loss of function is allowed, provided the function is self-recoverable or can be restored by the operation of the controls. |

4.1.3 EUT OPERATING CONDITION

Same as item 3.1.6



4.2 ELECTROSTATIC DISCHARGE IMMUNITY TEST (ESD)

4.2.1 TEST SPECIFICATION

| | |
|----------------------|--|
| Basic Standard: | IEC 61000-4-2 |
| Discharge Impedance: | 330 ohm / 150 pF |
| Discharge Voltage: | Air Discharge: 8 kV (Direct) Contact Discharge: 4 kV (Indirect) |
| Polarity: | Positive & Negative |
| Number of Discharge: | 20 times at each test point |
| Discharge Mode: | Single Discharge |
| Discharge Period: | 1 second |

4.2.2 TEST INSTRUMENTS

| Equipment | Manufacturer | Model No. | Serial No. | Last Cal. | Next Cal. |
|---------------|--------------|-----------|-------------|-------------|-------------|
| ESD Generator | TESEQ | NSG 437 | 279 | Oct. 12, 13 | Oct. 11, 14 |
| Test Software | TESEQ | V03.03 | N/A | N/A | N/A |
| ESD Generator | EM TEST | Dito | V1211112265 | Jun. 19,14 | Jun. 18,15 |
| Test Software | EM TEST | V 2.31 | N/A | N/A | N/A |

NOTE: 1. The test was performed in ESD Room.

2. The calibration interval of the above test instruments is 12 months and the calibrations are traceable to CEPREI/CHINA, GRGT/CHINA and NIM/CHINA.



4.2.3 TEST PROCEDURE

The basic test procedure was in accordance with IEC 61000-4-2:

- a. Electrostatic discharges were applied only to those points and surfaces of the EUT that are accessible to users during normal operation.
- b. The test was performed with at least ten single discharges on the pre-selected points in the most sensitive polarity.
- c. The time interval between two successive single discharges was at least 1 second.
- d. The ESD generator was held perpendicularly to the surface to which the discharge was applied and the return cable was at least 0.2 meters from the EUT.
- e. Contact discharges were applied to the non-insulating coating, with the pointed tip of the generator penetrating the coating and contacting the conducting substrate.
- f. Air discharges were applied with the round discharge tip of the discharge electrode approaching the EUT as fast as possible (without causing mechanical damage) to touch the EUT. After each discharge, the ESD generator was removed from the EUT and re-triggered for a new single discharge. The test was repeated until all discharges were complete.
- g. At least ten single discharges (in the most sensitive polarity) were applied to the Horizontal Coupling Plane at points on each side of the EUT. The ESD generator was positioned horizontal at a distance of 0.1 meters from the EUT with the discharge electrode touching the HCP.
- h. At least ten single discharges (in the most sensitive polarity) were applied to the center of one vertical edge of the Vertical Coupling Plane in sufficiently different positions that the four faces of the EUT were completely illuminated. The VCP (dimensions 0.5m x 0.5m) was placed vertically to and 0.1 meters from the EUT.

4.2.4 DEVIATION FROM TEST STANDARD

No Deviation

4.2.5 TEST SETUP

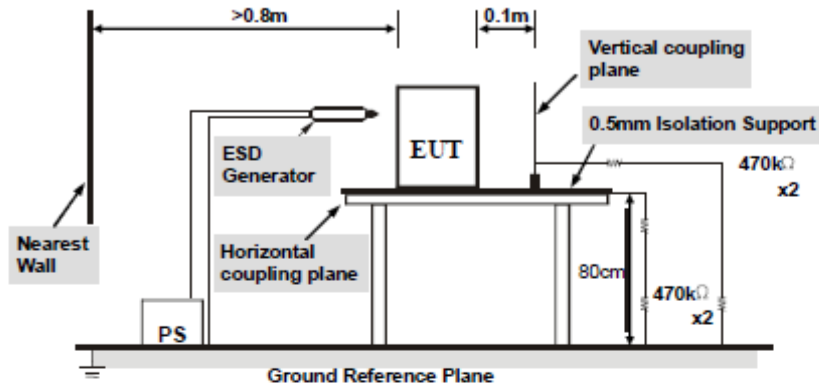

NOTE:

TABLE-TOP EQUIPMENT

The configuration consisted of a wooden table 0.8 meters high standing on the Ground Reference Plane. The GRP consisted of a sheet of aluminum at least 0.25mm thick, and 2.5 meters square connected to the protective grounding system. A Horizontal Coupling Plane (1.6m x 0.8m) was placed on the table and attached to the GRP by means of a cable with 940kΩ total impedance. The equipment under test, was installed in a representative system as described in section 7 of IEC 61000-4-2, and its cables were placed on the HCP and isolated by an insulating support of 0.5mm thickness. A distance of 1-meter minimum was provided between the EUT and the walls of the laboratory and any other metallic structure.

FLOOR-STANDING EQUIPMENT

The equipment under test was installed in a representative system as described in section 7 of IEC 61000-4-2, and its cables were isolated from the Ground Reference Plane by an insulating support of 0.1-meter thickness. The GRP consisted of a sheet of aluminum that is at least 0.25mm thick, and 2.5 meters square connected to the protective grounding system and extended at least 0.5 meters from the EUT on all sides.



4.2.6 TEST RESULTS

| | | | |
|---------------------------------|--------------------------------|-------------------------|---------|
| TEST MODE | See item 2.2 | TEST VOLTAGE | DC 300V |
| ENVIRONMENTAL CONDITIONS | 21.2deg. C, 51% RH 101.3kPa | TESTED BY: Heise | |

| Direct Discharge Application | | | | |
|------------------------------|----------|--------------------|----------------------------------|------------------------------|
| Test Level (kV) | Polarity | Test Point | Test Result of Contact Discharge | Test Result of Air Discharge |
| 4 | +/- | All Metal Part | A | N/A |
| 8 | +/- | All Non-metal Part | N/A | A |

| Indirect Discharge Application | | | | |
|--------------------------------|----------|------------|--------------------|--------------------|
| Discharge Level (kV) | Polarity | Test Point | Test Result of HCP | Test Result of VCP |
| 4 | +/- | HCP&VCP | A | A |

NOTE: A: There was no change compared with initial operation during the test.



4.3 RADIATED, RADIO-FREQUENCY, ELECTROMAGNETIC FIELD IMMUNITY TEST (RS)

4.3.1 TEST SPECIFICATION

| | |
|----------------------|--|
| Basic Standard: | IEC 61000-4-3 |
| Frequency Range: | 80-1000MHz, 1400-2000MHz, 2000-2700MHz |
| Field Strength: | 10V/m, 3V/m, 1V/m |
| Modulation: | 1kHz Sine Wave, 80%, AM Modulation |
| Frequency Step: | 1 % of fundamental |
| Polarity of Antenna: | Horizontal and Vertical |
| Antenna Height: | 1.5m |
| Dwell Time: | at least 3 seconds |

4.3.2 TEST INSTRUMENTS

| Equipment | Manufacturer | Model No. | Serial No. | Last Cal. | Next Cal. |
|--------------------------|--------------|------------------------|------------|------------|------------|
| Signal Generator | Agilent | N5181A | MY50142530 | Nov. 01,13 | Oct. 31,14 |
| Antenna Log-Periodic | CORAD | ATR80M6G | 0337307 | N/A | N/A |
| Antenna Log-Periodic | CORAD | ATS700M11G | 0336821 | N/A | N/A |
| Switch Controller | CORAD | SC1000 | 0337343 | N/A | N/A |
| RF Power Meter | ESE | 4242 | 13984 | Nov. 04,13 | Nov. 03,14 |
| Power Sensor | ESE | 51011EMC | 35716 | Nov. 04,13 | Nov. 03,14 |
| Power Sensor | ESE | 51011EMC | 35715 | Nov. 04,13 | Nov. 03,14 |
| E-Field probe | Narda | NBM-520 | 2403/01B | May 07,14 | May 06,15 |
| Power Amplifier | TESEQ | CBA 1G-150 | T44029 | N/A | N/A |
| Power Amplifier | TESEQ | CBA 3G-100 | T44030 | N/A | N/A |
| Power Amplifier | TESEQ | CBA 6G-050 | 1041204 | N/A | N/A |
| Dual Directional Coupler | TESEQ | C5982 | 95208 | Dec. 23,13 | Dec. 22,14 |
| Dual Directional Coupler | TESEQ | C6187 | 95175 | Dec. 23,13 | Dec. 22,14 |
| Dual Directional Coupler | TESEQ | CPH-274F | M251304-01 | Dec. 23,13 | Dec. 22,14 |
| Test Software | ADT | BVADT_RS_V7.6 .4-DG | N/A | N/A | N/A |

NOTE: 1. The test was performed in RS chamber.

2. The calibration interval of the above test instruments is 12 months and the calibrations are traceable to CEPREI/CHINA, GRGT/CHINA and NIM/CHINA.



4.3.3 TEST PROCEDURE

The test procedure was in accordance with IEC 61000-4-3

- a. The testing was performed in a fully-anechoic chamber.
- b. The frequency range is swept from 80 MHz to 1000 MHz, 1400MHz to 2000MHz, 2000MHz to 2700MHz with the signal 80% amplitude modulated with a 1kHz sine wave.
- c. The dwell time at each frequency shall not be less than the time necessary for the EUT to be exercised and to respond, but shall in no case be less than 0,5s.
- d. The field strength levels were 10V/m, 3V/m, 1V/m.
- e. The test was performed with the EUT exposed to both vertically and horizontally polarized fields on each of the four sides.

4.3.4 DEVIATION FROM TEST STANDARD

No Deviation

4.3.5 TEST SETUP

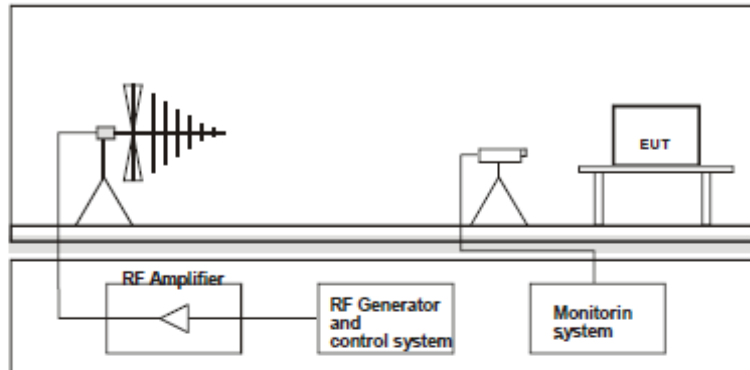

NOTE:

TABLETOP EQUIPMENT

The EUT installed in a representative system as described in section 7 of IEC 61000-4-3 was placed on a non-conductive table 0.8 meters in height. The system under test was connected to the power and signal wire according to relevant installation instructions.

FLOOR STANDING EQUIPMENT

The EUT installed in a representative system as described in section 7 of IEC 61000-4-3 was placed on a non-conductive wood support 0.1 meters in height. The system under test was connected to the power and signal wire according to relevant installation instructions.



4.3.6 TEST RESULTS

| | | | |
|---------------------------------|----------------------|-------------------------|---------|
| TEST MODE | See item 2.2 | TEST VOLTAGE | DC 300V |
| ENVIRONMENTAL CONDITIONS | 21.6deg. C, 57.5% RH | TESTED BY: Heise | |

| Field Strength (V/m) | Test Frequency Note#1 (MHz) | Polarization of antenna (Horizontal / Vertical) | Test Distance (m) | Test Result | Remark |
|----------------------|-----------------------------|---|-------------------|-------------|--------|
| 10 | 80 - 1000 | H&V | 3 | A | N/A |
| 3 | 1400 - 2000 | H&V | 3 | A | N/A |
| 1 | 2000 - 2700 | H&V | 3 | A | N/A |

Note*1:

Tested Israel SII Frequencies 89,100,107,144,163,196,244,315,434,460,600,825,845,880 MHz

NOTE: A: There was no change compared with initial operation during the test.



4.4 ELECTRICAL FAST TRANSIENT/BURST IMMUNITY TEST (EFT)

4.4.1 TEST SPECIFICATION

| | |
|---------------------|---------------------|
| Basic Standard: | IEC 61000-4-4 |
| Test Voltage: | Power Line: 2kV |
| Polarity: | Positive & Negative |
| Impulse Frequency: | 5 kHz |
| Impulse Waveshape : | 5/50 ns |
| Burst Duration: | 15 ms |
| Burst Period: | 300 ms |
| Test Duration: | 1 min. |

4.4.2 TEST INSTRUMENTS

| Equipment | Manufacturer | Model No. | Serial No. | Last Cal. | Next Cal. |
|--------------------|--------------|---------------|------------|-----------|-----------|
| EFT Tester | HAEFELY | PEFT4010 | 150546 | May 17,14 | May 16,15 |
| EFT Coupling Clamp | HAEFELY | IP4A | 150407 | May 17,14 | May 16,15 |
| Test Software | HAEFELY | SWPE4010 1.22 | N/A | N/A | N/A |

NOTE: 1. The test was performed in EMS Room 1.

2. The calibration interval of the above test instruments is 12 months and the calibrations are traceable to CEPREI/CHINA, GRGT/CHINA and NIM/CHINA.

4.4.3 TEST PROCEDURE

- Both positive and negative polarity discharges were applied.
- The length of the "hot wire" from the coaxial output of the EFT generator to the terminals on the EUT should not exceed 0.5 meter \pm 0.05 meter.
- The duration time of each test sequential was 1 minute.
- The transient/burst waveform was in accordance with IEC 61000-4-4, 5/50ns.

4.4.4 DEVIATION FROM TEST STANDARD

No deviation.

4.4.5 TEST SETUP

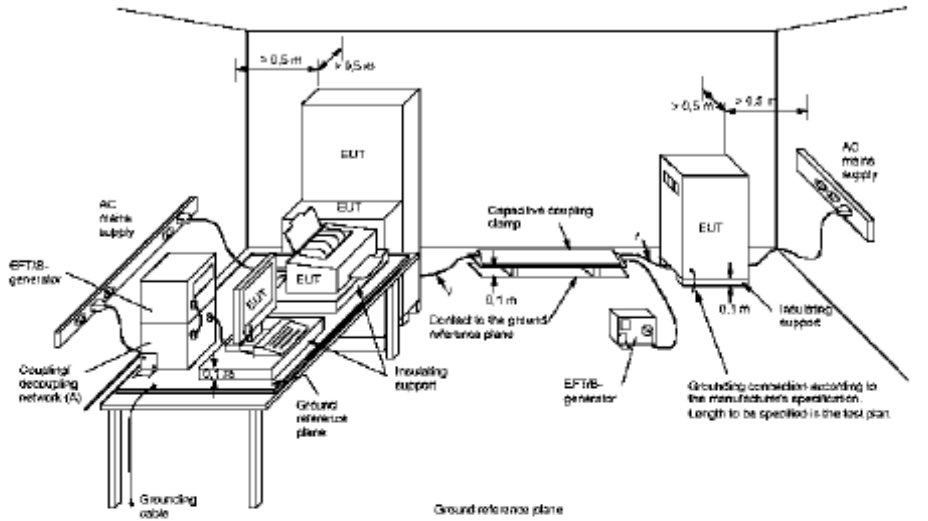

NOTE:

TABLETOP EQUIPMENT

The configuration consisted of a wooden table standing on the Ground Reference Plane and should be located 0.1m +/- 0.01m above the Ground Reference Plane.

The GRP consisted of a sheet of aluminum (at least 0.25mm thick and 2.5m square) connected to the protective grounding system. A minimum distance of 0.5m was provided between the EUT and the walls of the laboratory or any other metallic structure.

FLOOR STANDING EQUIPMENT

The EUT installed in a representative system as described in section 7 of IEC 61000-4-4 and its cables, were isolated from the Ground Reference Plane by an insulating support that is 0.1-meter thick. The GRP consisted of a sheet of aluminum (at least 0.25mm thick and 2.5m square) connected to the protective grounding system.

Bureau Veritas Shenzhen Co., Ltd.
Dongguan Branch

No. 34, Chenwulu Section, Guantai Rd., Houjie
Town, Dongguan City,
Guangdong 523942, China

Tel: +86 769 8593 5656
Fax: +86 769 8593 1080
Email: customerservice.dg@cn.bureauveritas.com



4.4.6 TEST RESULTS

| | | | |
|--------------------------|-----------------------|------------------|---------|
| TEST MODE | See item 2.2 | TEST VOLTAGE | DC 300V |
| ENVIRONMENTAL CONDITIONS | 21.5 deg. C, 58.2% RH | TESTED BY: Heise | |

| Pulse Voltage | 2 kV | | kV | | kV | | kV | |
|---------------|------|---|----|---|----|---|----|---|
| | + | - | + | - | + | - | + | - |
| L | A | A | / | / | / | / | / | / |
| N | A | A | / | / | / | / | / | / |
| PE | A | A | / | / | / | / | / | / |
| L+N | A | A | / | / | / | / | / | / |
| L+PE | A | A | / | / | / | / | / | / |
| N+PE | A | A | / | / | / | / | / | / |
| L+N+PE | A | A | / | / | / | / | / | / |
| DC Line | A | A | / | / | / | / | / | / |

NOTE: A: There was no change compared with initial operation during the test.



BUREAU VERITAS Test Report No.: CE140508N005R1

4.5 SURGE IMMUNITY TEST

4.5.1 TEST SPECIFICATION

| | |
|-------------------------------|--|
| Basic Standard: | IEC 61000-4-5 |
| Wave-Shape: | Combination Wave 1.2/50 us Open Circuit Voltage 8 /20 us Short Circuit Current |
| Test Voltage: | AC Power Line: Line to Line:1kV Line to PE:2kV Signal Line: 1kV DC Power Line: Line to Line:0.5kV Line to PE:0.5kV |
| Surge Input/Output: | L-N&L-PE&N-PE, RJ 45 Line |
| Generator Source | 2 ohm between networks |
| Impedance: | 12 ohm between network and ground |
| Polarity: | Positive/Negative |
| Phase Angle: | 0° /90°/180°/270° |
| Pulse Repetition Rate: | 1 time / 60 sec. |
| Number of Tests: | 5 positive and 5 negative at selected points |

4.5.2 TEST INSTRUMENTS

| Equipment | Manufacturer | Model No. | Serial No. | Last Cal. | Next Cal. |
|-------------------------|--------------|-----------------------|------------|-------------|-------------|
| Combination wave Module | TESEQ AG | CDN 3061 | 1361 | Feb. 17, 14 | Feb. 16, 15 |
| Telecom Surge Module | TESEQ AG | NSG 3060 Mainframe | 1404 | Feb. 17, 14 | Feb. 16, 15 |
| CDN | TESEQ | CDN HSS-2 | 34275 | Nov.06, 13 | Nov.05, 14 |
| CDN | TESEQ | CDN 118 | 30741 | Nov.06, 13 | Nov.05, 14 |
| Test Software | TESEQ | CDM 3061_0002.30 | 1361 | N/A | N/A |
| Test Software | TESEQ | HVM 3060_0002.30 | 293 | N/A | N/A |

- NOTE: 1. The test was performed in EMS Room 1.
2. The calibration interval of the above test instruments is 12 months and the calibrations are traceable to CEPREI/CHINA, GRGT/CHINA and NIM/CHINA.

Bureau Veritas Shenzhen Co., Ltd.
Dongguan Branch

No. 34, Chenwulu Section, Guantai Rd., Houjie
Town, Dongguan City,
Guangdong 523942, China

Tel: +86 769 8593 5656
Fax: +86 769 8593 1080
Email: customerservice.dg@cn.bureauveritas.com

Page 49 of 66

Report Version 1

Bureau Veritas Shenzhen Co., Ltd.
Dongguan Branch

No. 34, Chenwulu Section, Guantai Rd.,
Houjie Town, Dongguan City, Guangdong
523942, China
Page 83 of 127

Tel: +86 769 8593 5656
Fax: +86 769 8599 1080
Email: customerservice.dg@cn.bureauveritas.com
TEST REPORT EN 50438 VER.1



4.5.3 TEST PROCEDURE

a. For EUT power supply:

The surge is to be applied to the EUT power supply terminals via the capacitive coupling network. Decoupling networks are required in order to avoid possible adverse effects on equipment not under test that may be powered by the same lines, and to provide sufficient decoupling impedance to the surge wave. The power cord between the EUT and the coupling/decoupling networks shall be 2 meters in length (or shorter).

b. For test applied to unshielded unsymmetrically operated interconnection lines of EUT:

The surge is applied to the lines via the capacitive coupling. The coupling / decoupling networks shall not influence the specified functional conditions of the EUT. The interconnection line between the EUT and the coupling/decoupling networks shall be 2 meters in length (or shorter).

c. For test applied to unshielded symmetrically operated interconnection / telecommunication lines of EUT:

The surge is applied to the lines via gas arrestors coupling. Test levels below the ignition point of the coupling arrestor cannot be specified. The interconnection line between the EUT and the coupling/decoupling networks shall be 2 meters in length (or shorter).

4.5.4 DEVIATION FROM TEST STANDARD

No deviation.

4.5.5 TEST SETUP

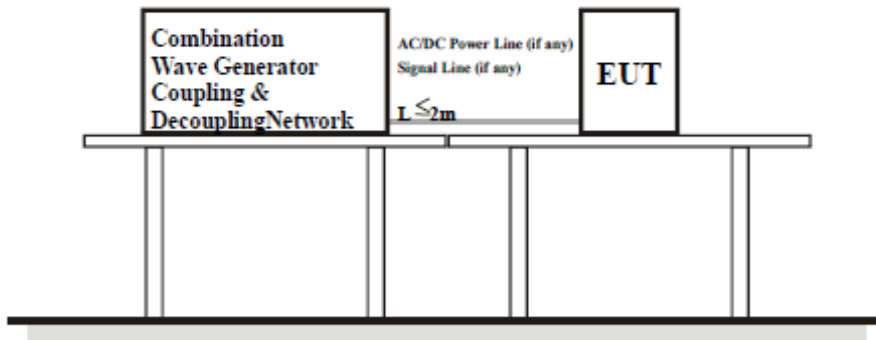



4.5.6 TEST RESULTS

| | | | |
|---------------------------------|----------------------|-------------------------|---------|
| TEST MODE | See item 2.2 | TEST VOLTAGE | DC 300V |
| ENVIRONMENTAL CONDITIONS | 21.5deg. C, 59.2% RH | TESTED BY: Heise | |

AC/DC Power port:

| Voltage (kV) | Phase angle \ Test point | Test result Polarity | 0° | 90° | 180° | 270° | DC Power Port |
|--------------|--------------------------|----------------------|----|-----|------|------|---------------|
| | | | | | | | |
| 1 | L-N | + | B | B | B | B | N/A |
| | | - | B | B | B | B | N/A |
| 2 | L-PE | + | B | B | B | B | N/A |
| | | - | B | B | B | B | N/A |
| 2 | N-PE | + | B | B | B | B | N/A |
| | | - | B | B | B | B | N/A |

Signal ports and telecommunication ports:

| Voltage (kV) | Test Point | Polarity | Test result | Voltage (kV) | Test Point | Polarity | Test result |
|--------------|------------|----------|-------------|--------------|------------|----------|-------------|
| / | / | +/- | / | / | / | +/- | / |

NOTE: A: There was no change compared with initial operation during the test.

B: During test, EUT stopped grid, and could automatically return to normal after test.



4.6 IMMUNITY TO CONDUCTED DISTURBANCES INDUCED BY RF FIELDS (CS)

4.6.1 TEST SPECIFICATION

| | |
|------------------|------------------------------------|
| Basic Standard: | IEC 61000-4-6 |
| Frequency Range: | 0.15 MHz - 80 MHz |
| Field Strength: | 10V _{r.m.s} |
| Modulation: | 1kHz Sine Wave, 80%, AM Modulation |
| Frequency Step: | 1 % of fundamental |
| Coupled Cable: | Power Mains & DC Power Line |
| Coupling Device: | CDN-M3(3 wires) & Clamp |

4.6.2 TEST INSTRUMENTS

| Equipment | Manufacturer | Model No. | Serial No. | Last Cal. | Next Cal. |
|---------------------------------|---------------|-----------------|------------|------------|------------|
| Signal Generator | Rohde&Schwarz | SME06 | 829498/006 | Oct.15,13 | Oct.14, 14 |
| CDN | Luthi | L-801M2/M3 | 2015 | Oct.18,13 | Oct. 17,14 |
| CDN(AUX) | TESEQ | CDN M016 | 27452 | Nov. 20,13 | Nov. 19,14 |
| CDN | TESEQ | T200A | 26944 | Apr. 08,14 | Apr. 07,15 |
| CDN | TESEQ | T400A | 26536 | Apr. 08,14 | Apr. 07,15 |
| CDN | TESEQ | ST08A | 32256 | Apr. 08,14 | Apr. 07,15 |
| 6dB 50Watt Attenuator | HUBER+SUHNER | 5906.17.0005 | 303688 | Oct.15,13 | Oct.14,14 |
| Signal Amplifier | HAEFELY | PAMP250 | 149594 | NA | NA |
| Electromagnetic Injection Clamp | Luthi | EM101 | 35640 | Oct.16,13 | Oct.15,14 |
| C/S Test System | HAEFELY | WinPAMP | NSEMC002 | N/A | N/A |
| Test Software | ADT | BVADT_CS_V7.5.1 | N/A | N/A | N/A |

NOTE: 1. The test was performed in CS test room.

2. The calibration interval of the above test instruments is 12 months and the calibrations are traceable to CEPREI/CHINA, GRGT/CHINA and NIM/CHINA.



4.6.3 TEST PROCEDURE

- a. The EUT shall be tested within its intended operating and climatic conditions.
- b. An artificial hand was placed on the hand-held accessory and connected to the ground reference plane.
- c. The test shall be performed with the test generator connected to each of the coupling and decoupling devices in turn, while the other non-excited RF input ports of the coupling devices are terminated by a 50-ohm load resistor.
- d. The frequency range is swept from 150 kHz to 80 MHz, using the signal level established during the setting process and with a disturbance signal of 80 % amplitude. The signal is modulated with a 1 kHz sine wave, pausing to adjust the RF signal level or the switch coupling devices as necessary. Where the frequency is swept incrementally, the step size shall not exceed 1 % of the preceding frequency value.
- e. The dwell time of the amplitude modulated carrier at each frequency shall not be less than the time necessary for the EUT to be exercised and to respond, but shall in no case be less than 0,5 s. The sensitive frequencies (e.g. clock frequencies) shall be analyzed separately.
- f. Attempts should be made to fully exercise the EUT during testing, and to fully interrogate all exercise modes selected for susceptibility.

4.6.4 DEVIATION FROM TEST STANDARD

No deviation.

4.6.5 TEST SETUP

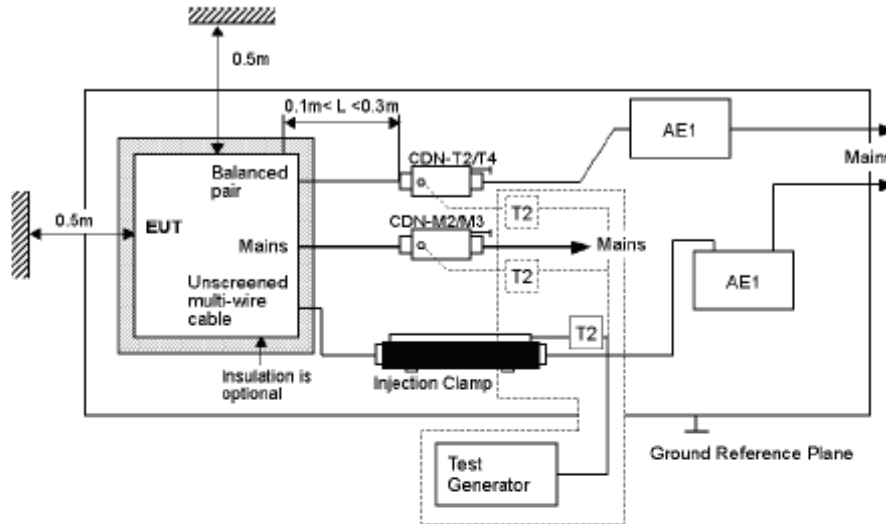

NOTE: The EUT clearance from any metallic obstacles shall be at least 0.5m.
All non-excited input ports of the CDNs shall be terminated by 50Ω loads.

NOTE:

FLOOR-STANDING EQUIPMENT

The equipment to be tested is placed on an insulating support of 0.1 meters height above a ground reference plane. All relevant cables shall be provided with the appropriate coupling and decoupling devices at a distance between 0.1 meters and 0.3 meters from the projected geometry of the EUT on the ground reference plane.



4.6.6 TEST RESULTS

| | | | |
|--------------------------|----------------------|--------------|---------|
| TEST MODE | See Item 2.2 | TEST VOLTAGE | DC 300V |
| ENVIRONMENTAL CONDITIONS | 22.5deg. C, 56.6% RH | TESTED BY: | Heise |

| Voltage (V) | Test Frequency Note ^{#1} (MHz) | Tested Line | Injection Method. | Test Result | Remark |
|-------------|---|-------------|-------------------|-------------|--------|
| 10 | 0.15 – 80 | AC Mains | CDN-M3 | A | N/A |
| 10 | 0.15 – 80 | DC line | Clamp | A | N/A |

Note^{#1}: Tested Israel SII Frequencies 0.2,0.53,1,1.5,7.1,13.56,21,27.12,40.68,65,68 MHz

NOTE: A: There was no change compared with initial operation during the test.



4.7 POWER FREQUENCY MAGNETIC FIELD IMMUNITY TEST

4.7.1 TEST SPECIFICATION

| | |
|-------------------|-------------------------|
| Basic Standard: | IEC 61000-4-8 |
| Frequency Range: | 50Hz, 60Hz |
| Field Strength: | 30A/m |
| Observation Time: | 5 minute |
| Inductance Coil: | Rectangular type, 1mx1m |

4.7.2 TEST INSTRUMENTS

| Equipment | Manufacturer | Model No. | Serial No. | Last Cal. | Next Cal. |
|-----------------------|--------------|-----------|------------|-----------|-----------|
| Magnetic Field Tester | HAEFELY | MAG100.1 | 150579 | Oct.18,13 | Oct.17,14 |
| Test Software | N/A | N/A | N/A | N/A | N/A |

NOTE: 1. The test was performed in Shielding Room 843.

2. The calibration interval of the above test instruments is 12 months and the calibrations are traceable to CEPREI/CHINA, GRGT/CHINA and NIM/CHINA.

4.7.3 TEST PROCEDURE

- The equipment is configured and connected to satisfy its functional requirements.
- The power supply, input and output circuits shall be connected to the sources of power supply, control and signal.
- The cables supplied or recommended by the equipment manufacturer shall be used. 1 meter of all cables used shall be exposed to the magnetic field.

4.7.4 DEVIATION FROM TEST STANDARD

No Deviation



4.7.5 TEST SETUP

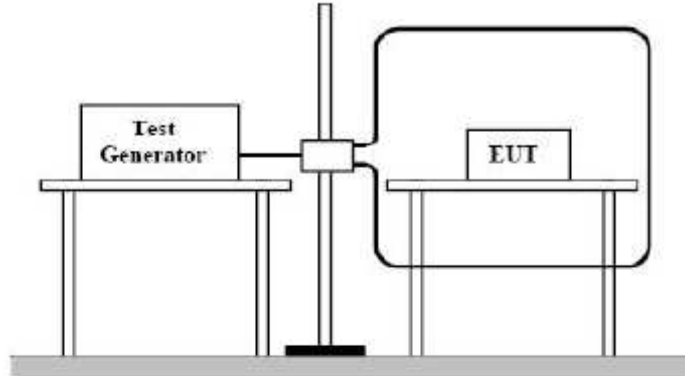

NOTE:

TABLETOP EQUIPMENT

The equipment shall be subjected to the test magnetic field by using the induction coil of standard dimension (1 m x 1 m). The induction coil shall then be rotated by 90 degrees in order to expose the EUT to the test field with different orientations.

FLOOR-STANDING EQUIPMENT

The equipment shall be subjected to the test magnetic field by using induction coils of suitable dimensions. The test shall be repeated by moving and shifting the induction coils, in order to test the whole volume of the EUT for each orthogonal direction. The test shall be repeated with the coil shifted to different positions along the side of the EUT, in steps corresponding to 50 % of the shortest side of the coil. The induction coil shall then be rotated by 90 degrees in order to expose the EUT to the test field with different orientations.



4.7.6 TEST RESULTS

| | | | |
|--------------------------|------------------|------------------|---------|
| TEST MODE | See Item 2.2 | TEST VOLTAGE | DC 300V |
| ENVIRONMENTAL CONDITIONS | 22deg. C, 59% RH | TESTED BY: Heise | |
| MAGNETIC FIELD DIRECTION | TESTING RESULT | REMARK | |
| X - Axis | A | 30A/ m | |
| Y - Axis | A | 30A/ m | |
| Z - Axis | A | 30A/ m | |

NOTE: A: There is no change compared with the initial operation during the test.



5 PHOTOGRAPHS OF THE TEST CONFIGURATION

CONDUCTED EMISSION TEST



RADIATED EMISSION TEST

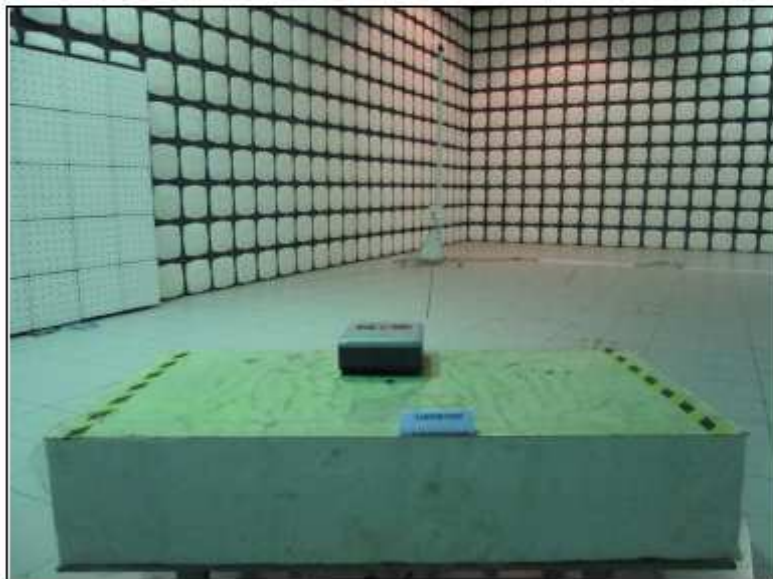
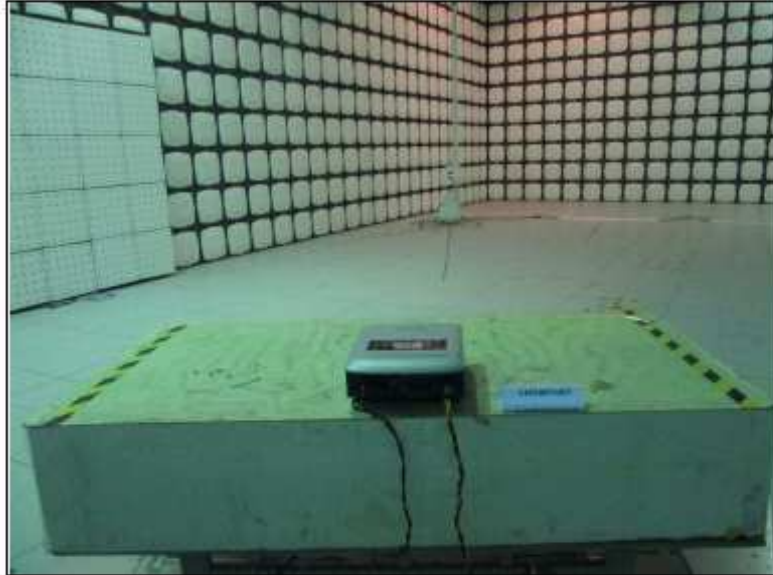

HARMONICS EMISSION TEST &
VOLTAGE FLUCTUATIONS AND FLICKER TEST



ESD TEST



Bureau Veritas Shenzhen Co., Ltd.
Dongguan Branch

No. 34, Chenwulu Section, Guantai Rd., Houjie
Town, Dongguan City,
Guangdong 523942, China

Tel: +86 769 8593 5656
Fax: +86 769 8593 1080
Email: customerservice.dg@cn.bureauveritas.com

Page 61 of 66

Report Version 1

Bureau Veritas Shenzhen Co., Ltd.
Dongguan Branch

No. 34, Chenwulu Section, Guantai Rd.,
Houjie Town, Dongguan City, Guangdong
523942, China
Page 95 of 127

Tel: +86 769 8593 5656
Fax: +86 769 8599 1080
Email: customerservice.dg@cn.bureauveritas.com
TEST REPORT EN 50438 VER.1

RS TEST

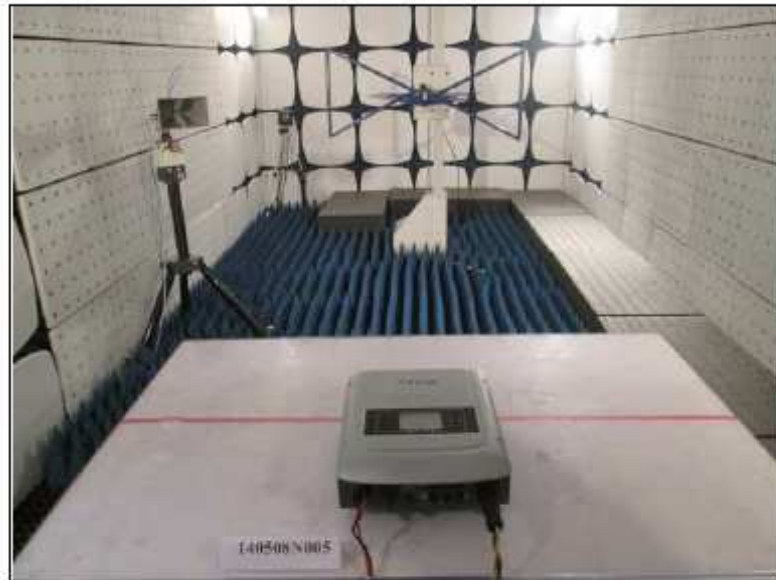

EFT TEST(AC Mains)



Test Report No.: CE140508N005R1

EFT TEST (DC Port)



SURGE TEST



Bureau Veritas Shenzhen Co., Ltd.
Dongguan Branch

No. 34, Chenwulu Section, Guantai Rd., Houjie
Town, Dongguan City,
Guangdong 523942, China

Tel: +86 769 8593 5656
Fax: +86 769 8593 1080
Email: customerservice_dg@cn.bureauveritas.com

Page 63 of 66

Report Version 1

Bureau Veritas Shenzhen Co., Ltd.
Dongguan Branch

No. 34, Chenwulu Section, Guantai Rd.,
Houjie Town, Dongguan City, Guangdong
523942, China
Page 97 of 127

Tel: +86 769 8593 5656
Fax: +86 769 8599 1080
Email: customerservice_dg@cn.bureauveritas.com
TEST REPORT EN 50438 VER.1

CONDUCTED SUSCEPTIBILITY TEST (AC Mains)



CONDUCTED SUSCEPTIBILITY TEST (DC Cable)



POWER-FREQUENCY MAGNETIC FIELDS TEST



6 APPENDIX A – MODIFICATIONS RECORDERS FOR ENGINEERING CHANGES TO THE EUT BY THE LAB

No any modifications were made to the EUT by the lab during the test.

--END--

Bureau Veritas Shenzhen Co., Ltd.
Dongguan Branch

No. 34, Chenwulu Section, Guantai Rd., Houjie
Town, Dongguan City,
Guangdong 523942, China

Tel: +86 769 8593 5656
Fax: +86 769 8593 1080
Email: customerservice.dg@cn.bureauveritas.com

Page 66 of 66

Report Version 1

Bureau Veritas Shenzhen Co., Ltd.
Dongguan Branch

No. 34, Chenwulu Section, Guantai Rd.,
Houjie Town, Dongguan City, Guangdong
523942, China
Page 100 of 127

Tel: +86 769 8593 5656
Fax: +86 769 8599 1080
Email: customerservice.dg@cn.bureauveritas.com
TEST REPORT EN 50438 VER.1

PHOTOGRAPHS OF THE EUT

SOFAR 1100TL:



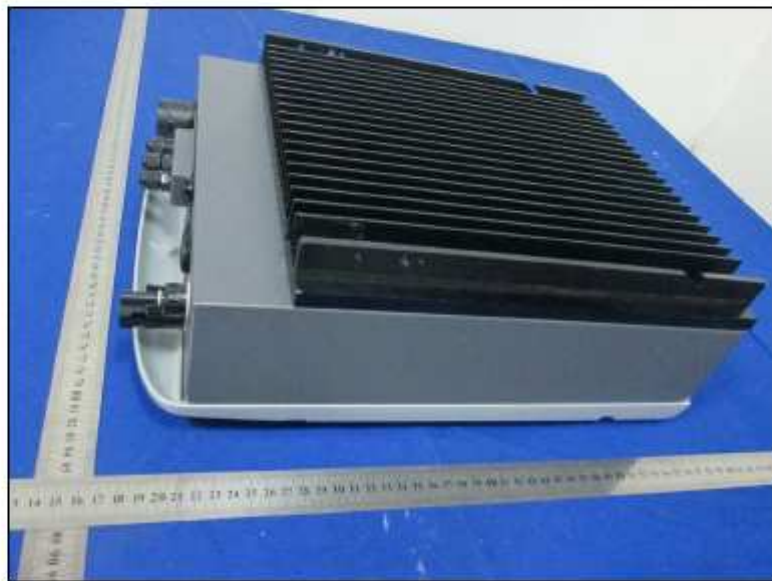
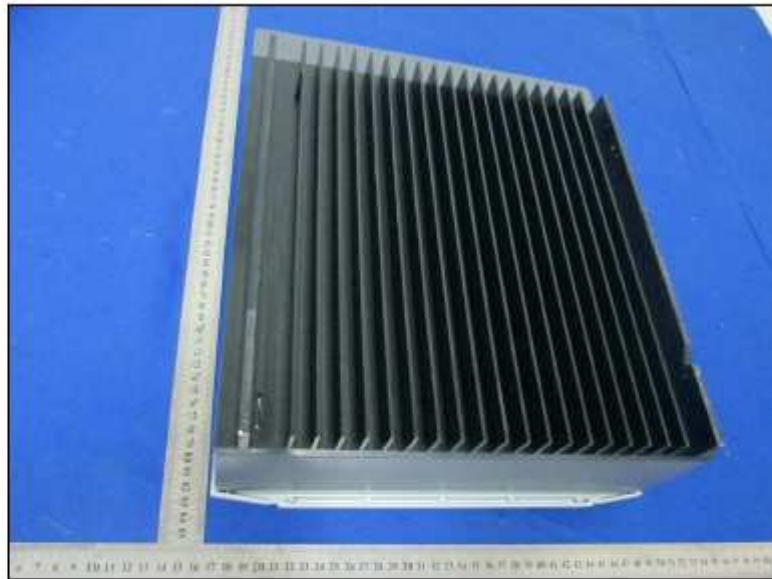

Bureau Veritas Shenzhen Co., Ltd.
Dongguan Branch

No. 34, Chenwulu Section, Guantai Rd., Houjie
Town, Dongguan City,
Guangdong 523942, China

Tel.: +86 769 8593 5656
Fax: +86 769 8593 1080
Email: customerservice.dg@cn.bureauveritas.com

Page 2 of 17

Report Version 1

Bureau Veritas Shenzhen Co., Ltd.
Dongguan Branch

No. 34, Chenwulu Section, Guantai Rd.,
Houjie Town, Dongguan City, Guangdong
523942, China
Page 102 of 127

Tel: +86 769 8593 5656
Fax: +86 769 8599 1080
Email: customerservice.dg@cn.bureauveritas.com
TEST REPORT EN 50438 VER.1



Bureau Veritas Shenzhen Co., Ltd.
Dongguan Branch

No. 34, Chenwulu Section, Guantai Rd., Houjie
Town, Dongguan City,
Guangdong 523942, China

Tel.: +86 769 8593 5656
Fax: +86 769 8593 1080
Email: customerservice.dg@cn.bureauveritas.com

Page 3 of 17

Report Version 1

Bureau Veritas Shenzhen Co., Ltd.
Dongguan Branch

No. 34, Chenwulu Section, Guantai Rd.,
Houjie Town, Dongguan City, Guangdong
523942, China
Page 103 of 127

Tel: +86 769 8593 5656
Fax: +86 769 8599 1080
Email: customerservice.dg@cn.bureauveritas.com
TEST REPORT EN 50438 VER.1





Bureau Veritas Shenzhen Co., Ltd.
Dongguan Branch

No. 34, Chenwulu Section, Guantai Rd., Houjie
Town, Dongguan City,
Guangdong 523942, China

Tel.: +86 769 8593 5656
Fax: +86 769 8593 1080
Email: customerservice.dg@cn.bureauveritas.com

Page 5 of 17

Report Version 1

Bureau Veritas Shenzhen Co., Ltd.
Dongguan Branch

No. 34, Chenwulu Section, Guantai Rd.,
Houjie Town, Dongguan City, Guangdong
523942, China
Page 105 of 127

Tel: +86 769 8593 5656
Fax: +86 769 8599 1080
Email: customerservice.dg@cn.bureauveritas.com
TEST REPORT EN 50438 VER.1

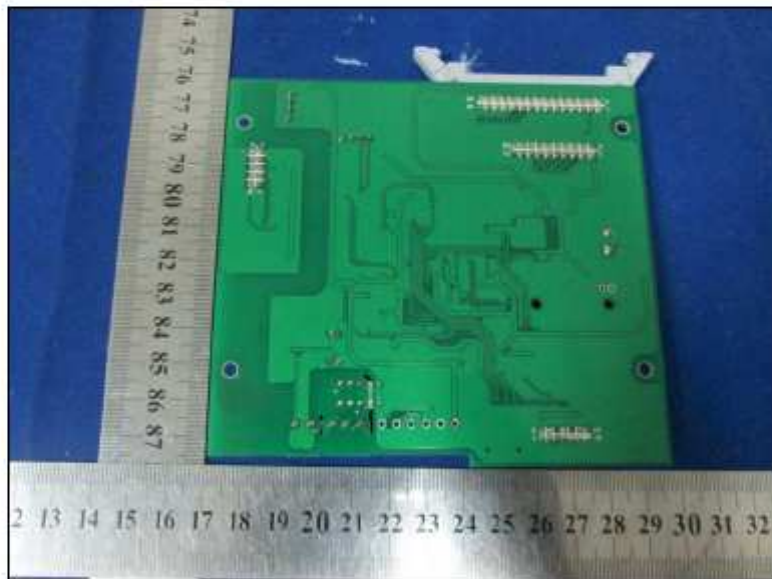

Bureau Veritas Shenzhen Co., Ltd.
Dongguan Branch

No. 34, Chenwulu Section, Guantai Rd., Houjie
Town, Dongguan City,
Guangdong 523942, China

Tel.: +86 769 8593 5656
Fax: +86 769 8593 1080
Email: customerservice.dg@cn.bureauveritas.com

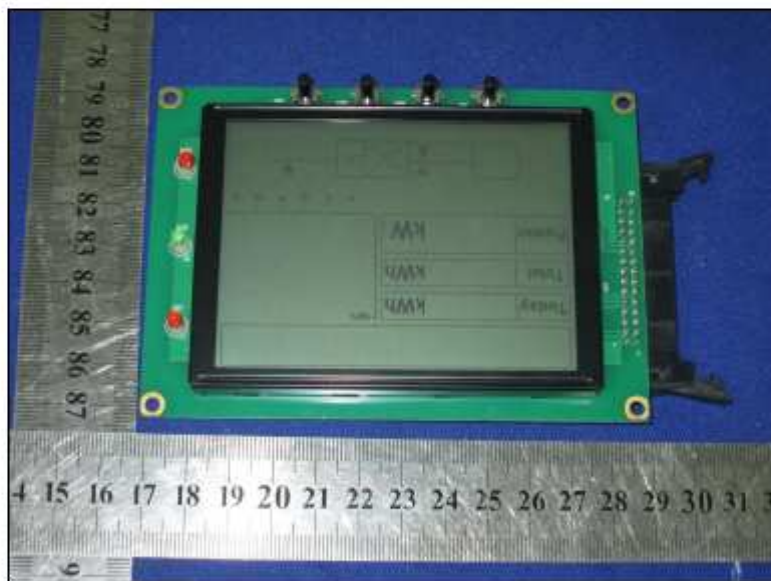

Bureau Veritas Shenzhen Co., Ltd.
Dongguan Branch

No. 34, Chenwulu Section, Guantai Rd., Houjie
Town, Dongguan City,
Guangdong 523942, China

Tel.: +86 769 8593 5656
Fax: +86 769 8593 1080
Email: customerservice.dg@cn.bureauveritas.com

Page 7 of 17

Report Version 1

Bureau Veritas Shenzhen Co., Ltd.
Dongguan Branch

No. 34, Chenwulu Section, Guantai Rd.,
Houjie Town, Dongguan City, Guangdong
523942, China
Page 107 of 127

Tel: +86 769 8593 5656
Fax: +86 769 8599 1080
Email: customerservice.dg@cn.bureauveritas.com
TEST REPORT EN 50438 VER.1



BUREAU
VERITAS

Reference No.: 140508N005R1

SOFAR 2200TL:



Bureau Veritas Shenzhen Co., Ltd.
Dongguan Branch

No. 34, Chenwulu Section, Guantai Rd., Houjie
Town, Dongguan City,
Guangdong 523942, China

Tel.: +86 769 8593 5656
Fax: +86 769 8593 1080
Email: customerservice.dg@cn.bureauveritas.com

Page 8 of 17

Report Version 1

Bureau Veritas Shenzhen Co., Ltd.
Dongguan Branch

No. 34, Chenwulu Section, Guantai Rd.,
Houjie Town, Dongguan City, Guangdong
523942, China
Page 108 of 127

Tel: +86 769 8593 5656
Fax: +86 769 8599 1080
Email: customerservice.dg@cn.bureauveritas.com
TEST REPORT EN 50438 VER.1

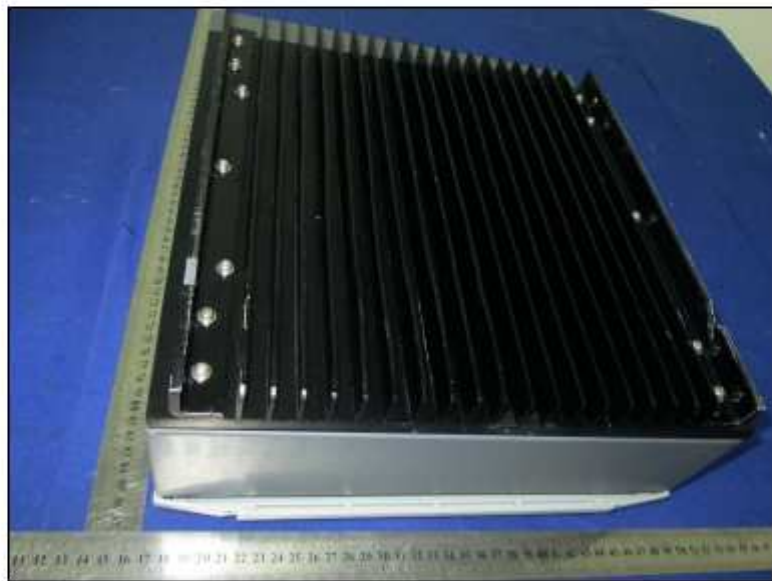

Bureau Veritas Shenzhen Co., Ltd.
Dongguan Branch

No. 34, Chenwulu Section, Guantai Rd., Houjie
Town, Dongguan City,
Guangdong 523942, China

Tel.: +86 769 8593 5656
Fax: +86 769 8593 1080
Email: customerservice.dg@cn.bureauveritas.com

Page 9 of 17

Report Version 1

Bureau Veritas Shenzhen Co., Ltd.
Dongguan Branch

No. 34, Chenwulu Section, Guantai Rd.,
Houjie Town, Dongguan City, Guangdong
523942, China
Page 109 of 127

Tel: +86 769 8593 5656
Fax: +86 769 8599 1080
Email: customerservice.dg@cn.bureauveritas.com
TEST REPORT EN 50438 VER.1



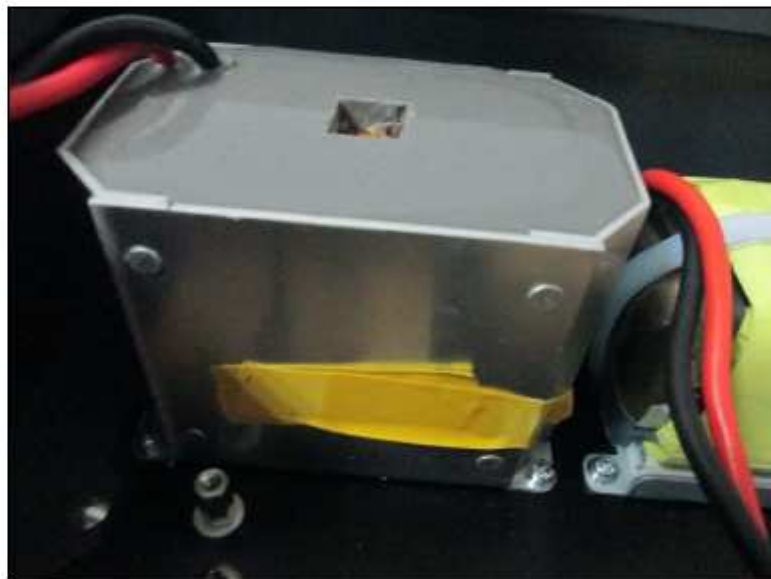

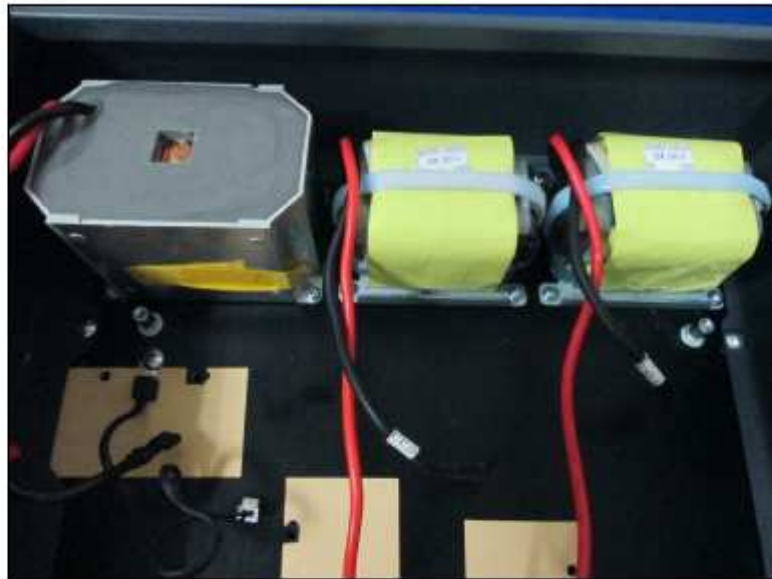

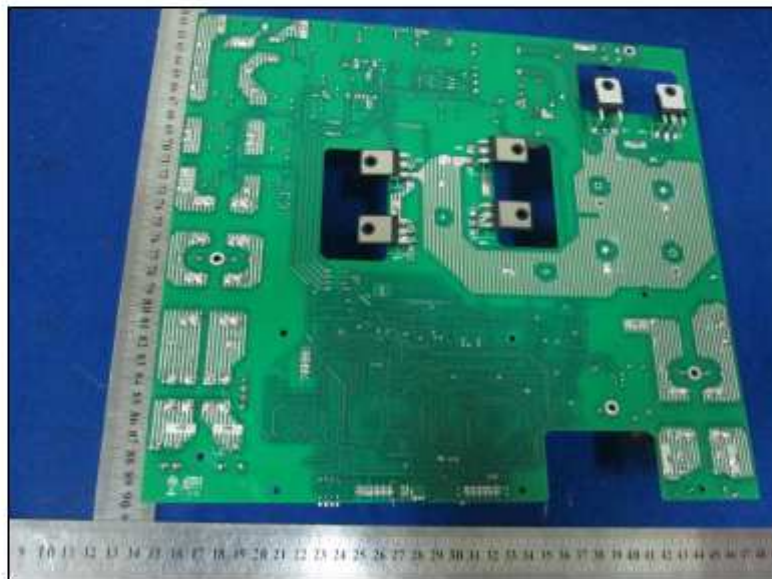

Bureau Veritas Shenzhen Co., Ltd.
Dongguan Branch

No. 34, Chenwulu Section, Guantai Rd., Houjie
Town, Dongguan City,
Guangdong 523942, China

Tel.: +86 769 8593 5656
Fax: +86 769 8593 1080
Email: customerservice.dg@cn.bureauveritas.com



SOFAR 3000TL:

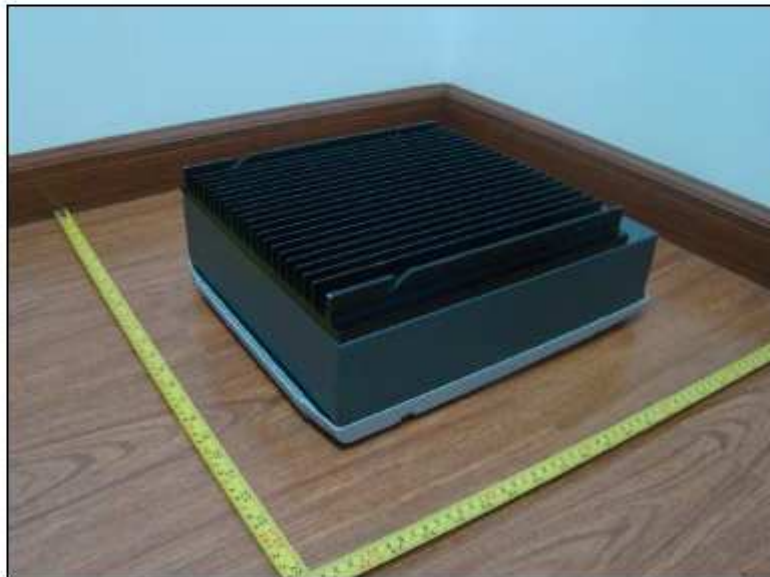



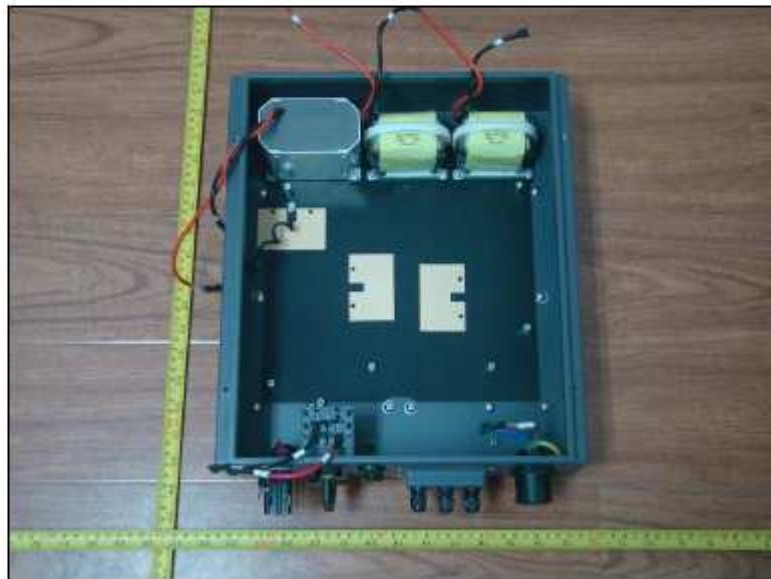



Annex 2

Pictures of the unit

Enclosure front view



Enclosure rear view



Enclosure bottom view



Internal view-1

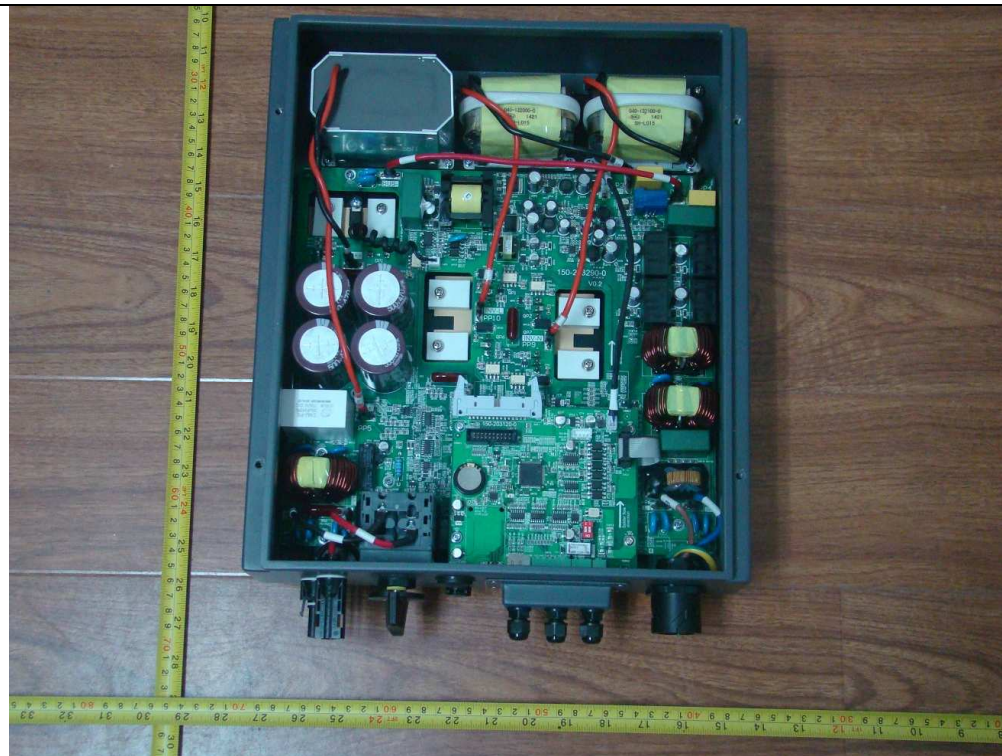

Internal view-2



Internal view-3

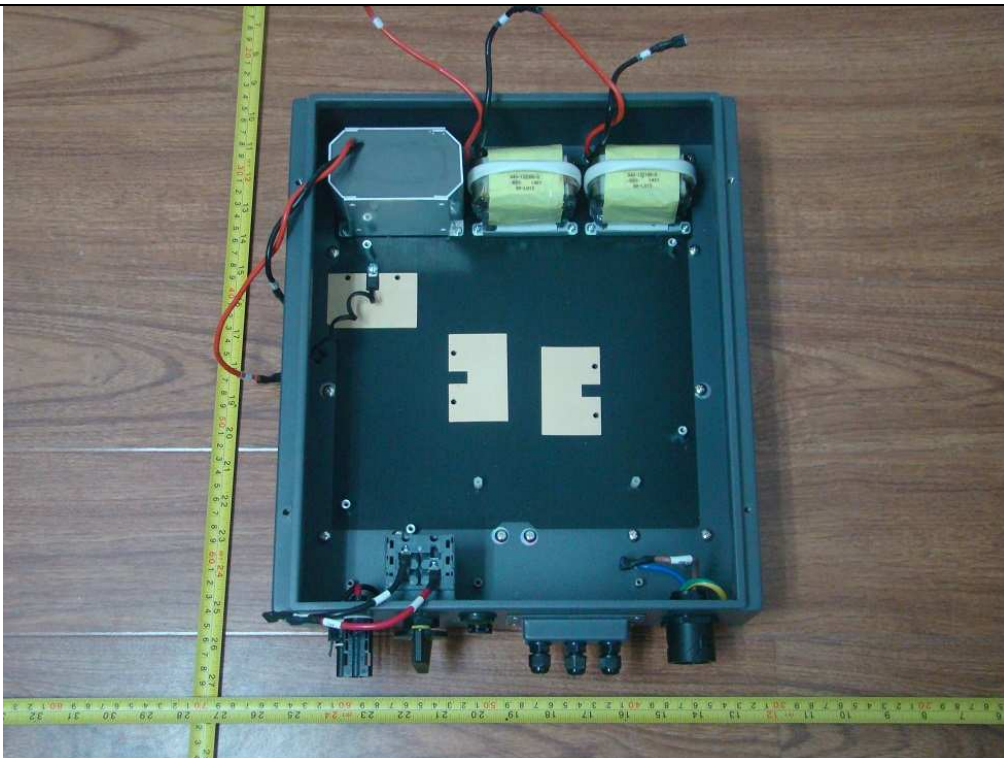

Internal view-4



Main power board component side view



Main power board solder side view



Control board component side view

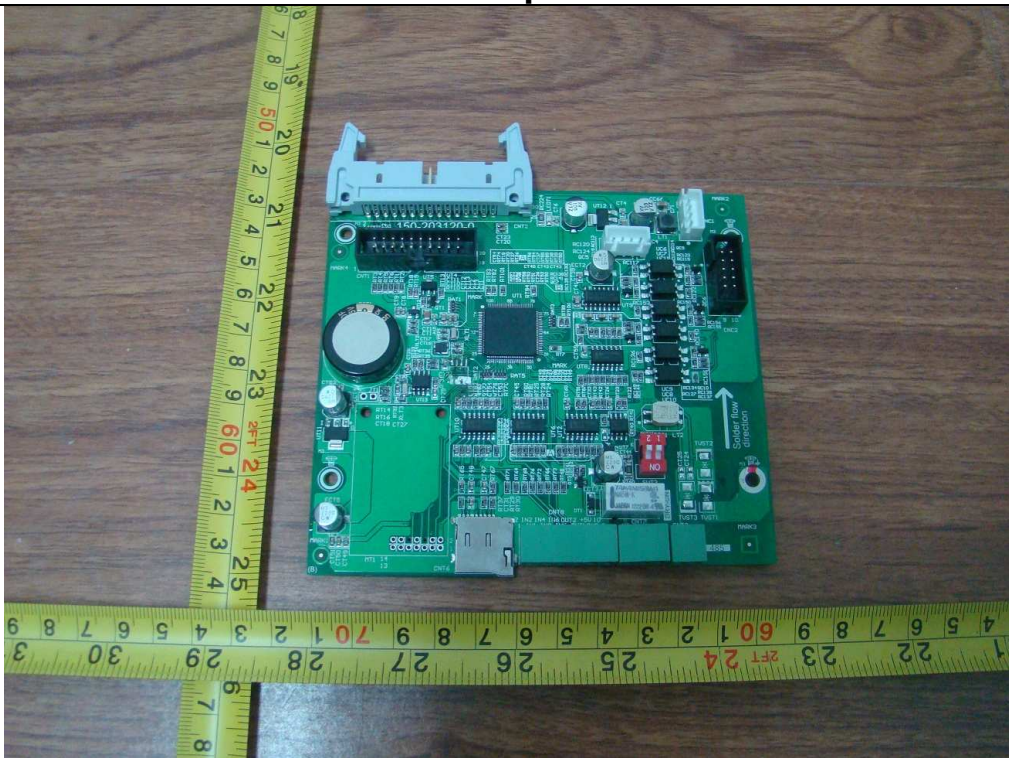

Control board solder side view

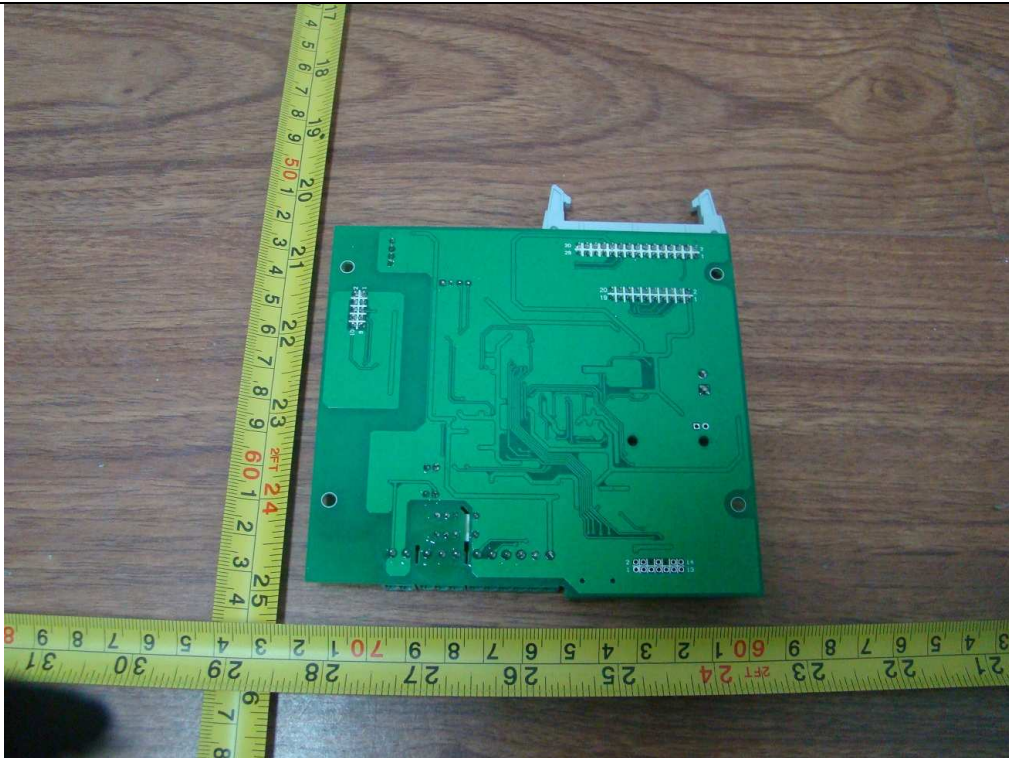

Display board component side view

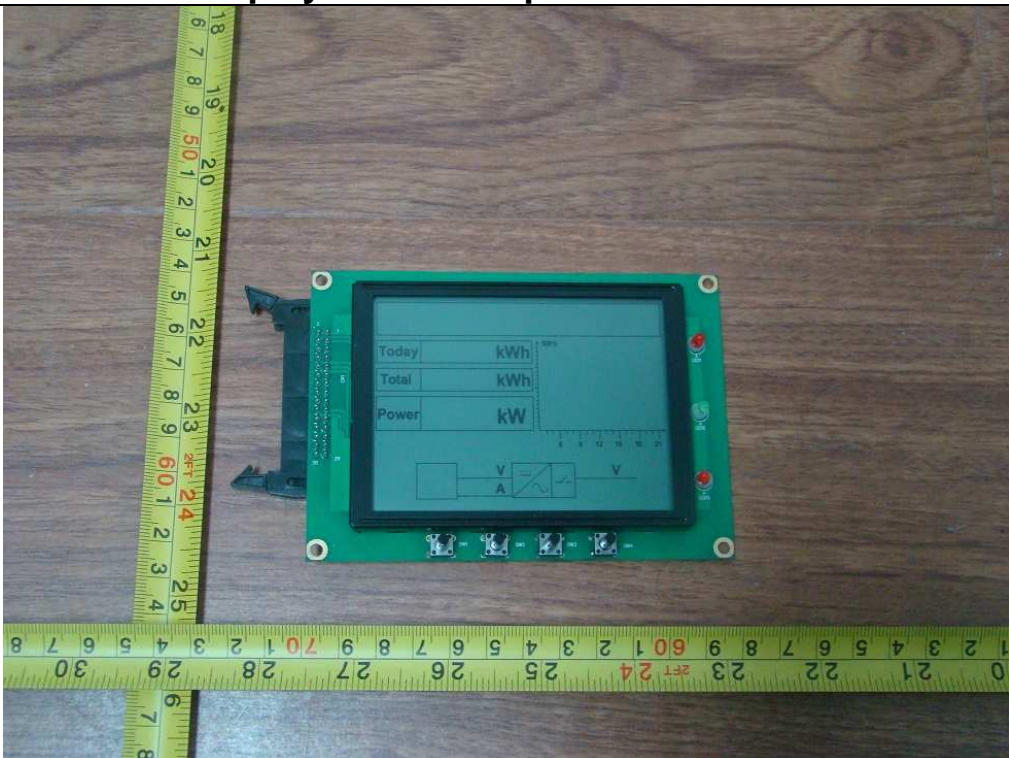

Display board solder side view

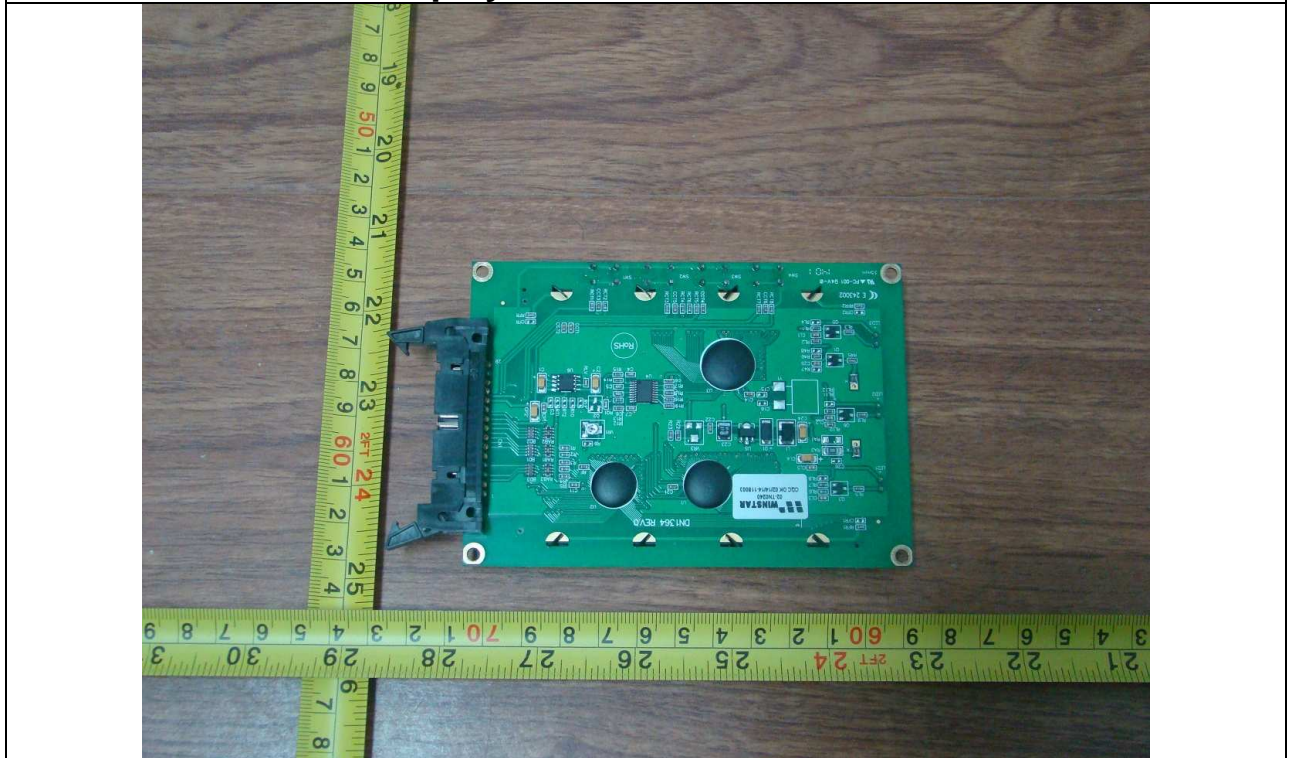

Annex 3

Test equipment list

| Equipment | Internal No. | Manufacturer | Type | Serial No. | Last Calibration |
|--|--------------|--------------|--------------|--------------|-----------------------------|
| Power Analyzer | A4080002DG | YOKOGAWA | WT3000 | 91M210852 | Mar. 12, 2014 |
| AC Source | A7040019DG | Chroma | 61512 | 61512000439 | Monitored by Power Analyzer |
| AC Source | A7040020DG | Chroma | 61512 | 61512000438 | Monitored by Power Analyzer |
| DC Simulation Power Supply | A7040015DG | Chroma | 62150H-1000S | 62150EF00488 | Monitored by Power Analyzer |
| DC Simulation Power Supply | A7040016DG | Chroma | 62150H-1000S | 62150EF00490 | Monitored by Power Analyzer |
| Four Channel Digital Phosphor Oscilloscope | A4089003DG | Tektronix | DPO4104B | C010624 | Oct. 17, 2013 |
| Current transducer | A1060007DG | YOKOGAWA | CT200 | 1130700012 | Jan 20, 2014 |
| RLC Load | A7150027DG | Qunling | ACLT-3803H | 93VOO2869 | Monitored by Power Analyzer |
| Oscilloscope probe | A4089010DG | Tektronix | TPP1000 | C008228 | Dec. 20, 2013 |
| Oscilloscope probe | A4089011DG | Tektronix | TPP1000 | C008229 | Dec. 20, 2013 |
| LCR Hitester | A1060006DG | HIOKI | 3535 | 120112505 | Mar. 06, 2014 |